

Draft for Release 2011a Beta

DRAFT
General Mission Analysis Tool (GMAT)
Estimation Components
Architectural Specification, Vol. II



The GMAT Development Team

Goddard Space Flight Center
Codes 583 and 595
Greenbelt, Maryland 20771

Thinking Systems, Inc.
6441 N Camino Libby
Tucson, Arizona 85718

April 21, 2011

Draft for Release 2011a Beta

Contents

Preface	v
I Estimation Overview	1
1 GMAT's Estimation Subsystem	3
1.1 Classes and their Responsibilities	3
1.1.1 Resources	4
1.1.2 Commands	5
1.1.3 Helper Classes	6
1.2 Collaboration between Classes	7
1.3 Walkthrough of Sample Script Execution	9
1.3.1 The Sample Script	9
1.3.2 Overview of a GMAT Run	10
1.3.3 Script Execution Walkthrough	13
II Estimation Components	21
2 The Estimators and Simulator	23
2.1 The Estimator Base Class	24
2.1.1 Key Processes	24
2.1.2 Estimator Members	25
2.2 The BatchEstimator Class	26
2.2.1 Key Processes	26
2.2.2 BatchEstimator Members	31
2.3 The BatchLeastSquares Class	32
2.3.1 Key Processes	32
2.3.2 BatchLeastSquares Members	32
2.4 The Simulator Class	33
2.4.1 Key Processes	33
2.4.2 Simulator Members	36
3 Commands used in Estimation and Simulation	39
3.1 Command Usage in GMAT	39
3.2 Estimation Command Overview	40
3.3 The RunEstimator Command	42
3.3.1 RunEstimator Members	43
3.4 The RunSimulator Command	44
3.4.1 Key Processes	46
3.4.2 Class Design	46

Draft for Release 2011a Beta

3.4.3	RunSimulator Members	46
4	Events and Event Location	49
4.1	Introduction	49
4.2	Components that Control Event Processing	49
4.3	The Event Location Process	50
4.4	Event Location Classes	52
4.4.1	Event Classes	52
4.4.2	The EventManager Class	55
4.4.3	The RootFinder Class	56
5	Measurement Classes and Measurement Models	57
5.1	The Measurement Class	57
5.1.1	Measurement Members	59
5.2	GroundstationMeasurement	60
5.2.1	GroundstationMeasurement Members	60
5.3	GroundStationRange	61
5.3.1	GroundstationRange Members	61
5.4	The MeasurementManager Class	62
6	Measurement Corrections	63
6.1	Introduction	63
6.2	Additive Corrections	63
6.3	Event Based Corrections	63
III	Estimation Examples	67

List of Figures

1.1	OD Components and Interactions	8
1.2	GMAT Run Overview – Running a Script	10
1.3	GMAT Run Overview – Top Level Action Details	11
1.4	Steps if the Sandbox Initialization Process	16
1.5	Reference Object Setting during Initialization	18
1.6	The Sandbox::Execute() Method	19
2.1	Classes in GMAT’s Estimator Hierarchy	23
2.2	The Estimator Class	25
2.3	Estimator Class Initialization	26
2.4	The BatchEstimator Class	27
2.5	Initialization in the BatchEstimator Class	27
2.6	Performing Batch Estimation	28
2.7	The BatchLeastSquares Class	32
2.8	The Simulator Class	33
2.9	The Simulation State Machine	34
3.1	Commands Used in Estimation	40
3.2	Top Level View of State Machine Execution	41
3.3	Interactions Between the RunEstimator Command and the Batch Least Squares Estimator	43
3.4	The Simulation State Machine	45
3.5	The RunSimulator Class	47
4.1	The Event Location Process	51
4.2	Event Location Classes	52
5.1	The Measurement Class Hierarchy	58
6.1	Steps in Light Time Correction: Two Way Range	64
6.2	Event Location for Measurements	65

Draft for Release 2011a Beta

iv

LIST OF FIGURES

Draft for Release 2011a Beta

Preface

This document describes the architecture and design of the components of GMAT built to support estimation. Readers are assumed to be familiar with GMAT's core architecture, presented in the GMAT Architectural Specification[ArchSpec].

Draft for Release 2011a Beta

vi

PREFACE

Draft for Release 2011a Beta

Part I

Estimation Overview

Draft for Release 2011a Beta

Chapter 1

GMAT's Estimation Subsystem

Stephen P. Hughes
NASA/Goddard Space Flight Center

Darrel J. Conway
Thinking Systems, Inc.

Matthew P. Wilkins
Schafer Corporation

In this chapter we present the highest level view of the proposed architectural design for estimation functionality in GMAT. We employ the Classes, Responsibilities, and Collaborations (CRC) method discussed by Eckel[Eckel] to describe the architecture. We start by describing the classes and their responsibilities. For each class we present a brief description and a bulleted list of primary responsibilities for instances of the class. Then, we discuss the allowable interactions and collaborations between the class instances. A diagram is presented that illustrates which classes/components can communicate with each other. For each allowable communication between classes, we discuss the reason for the interaction.

1.1 Classes and their Responsibilities

There are 10 classes designed or extended specifically for estimation that we discuss here. These classes are listed below.

- Resources
 - Participants (Spacecraft, GroundStation, etc.)¹
 - Estimator
 - Measurement
 - Simulator
 - Propagator¹
 - Event Locator
- Commands
 - RunEstimator

¹The marked classes exist and are extended to support estimation.

- RunSimulator
- Helpers
 - Measurement Manager
 - State Manager
 - Propagation State Manager¹
 - Estimation State Manager
 - File Reader and database*

Each class in this list has specific responsibilities and, with a few exceptions, all of the classes above are employed to solve estimation problems in GMAT. Next we will discuss the responsibilities of each class.

1.1.1 Resources

Participants Participants are models of physical objects and processes that partake in the measurement generation process. For a GPS measurement, the participants are the user spacecraft and the GPS constellation. For an altimeter measurement the participants are the spacecraft, and the central body. Participants such as spacecraft and ground stations already exist in GMAT, but will require modification to support estimation. In the long term, participants such as the TDRSS and GPS constellations and other Celestial bodies must be added to the system.

The classes for all measurement participants must contain specific functionality in order to support the modeling of measurements and other estimation related models. All participants must have methods to get and set specific types of data such as state data, state transition matrix data, and covariance data among others. In summary, participants must support the following get/set methods:

- GetState() and SetState()
- GetSTM() and SetSTM()
- GetCovariance() and SetCovariance()

Estimator The estimator class is the base class for all estimators. Estimators take observed and computed measurement values, and potentially measurement partial derivatives, and generate a sequence of state estimates until convergence or until stopping criteria are met. The estimator class contains the numerical methods such as batch least squares or the extended Kalman filter. In fact, most of the work involved in generating computed measurement values, including evaluating measurement models, determining visibility conditions, and applying measurement corrections, are invisible to the estimator class. Those functions are performed by two helper classes that provide bookkeeping and interfacing between the estimator and the measurement objects and participants. These helper classes are called the Estimator State Manager and the Measurement Manager and are discussed below. The primary responsibility of an Estimator is:

- Generate state estimates given observed and computed measurements, partial derivatives, weights, and a-priori covariances.

Measurements The measurement class is the base class for all measurements. For each measurement type such as GPS, TDRSS, and ground station, there is a class derived from the measurement base class. Similarly, for each measurement data type such as GPS pseudorange, or ground station right ascension and declination, there is a class derived from the appropriate parent class such as GPSMeasurement or GroundStationMeasurement. The measurement class performs modeling of expected measurements, given the participants in the measurement process. These modeling functions include calculating expected measurement values including corrections, calculating measurement partials, determining if the states of participants meet visibility

and other conditions that are required for measurement feasibility, and providing event function data for the iterative determination of light time corrections. In summary, the measurement classes have the following responsibilities:

- Calculate expected measurement values and measurement partials given the participants involved in the measurement process.
- Determine if criteria are met for measurement feasibility.
- Provide event function for tracking schedule generation and interface with event locator.
- Provide event functions and interface with event locator for iterative determination of light time correction, and propagation through deterministic event times such as averaging intervals.

Simulator The Measurement Simulator class simulates measurement observations. To perform its responsibilities, a simulator is provided a simulation time span and step size, a set of desired measurements to simulate, and a list of participants for the measurements, along with a propagator to use for propagation of the system. Similar to the estimator class, most of the work involved in generating simulated measurement values is invisible to the simulator class. For example, determining measurement feasibility, evaluating measurement models, and applying measurement corrections and errors are performed by the measurement objects themselves. To summarize, the Estimator:

- Generate simulated measurement values.

Event Locator The event locator, implemented in the RootFinder class, is a helper class for a propagator that controls propagation during the location of discrete events like eclipse entry or exit, or measurement light time corrections. In one mode, the event locator tracks event function root values during propagation and lets the propagator know when a discrete event has been bracketed. To locate the event, iterative root finding methods on the event locator control the propagation. In summary, the responsibilities of the event locator are:

- Bracket event function roots by identifying two points that surround a root.
- Iteratively solve for event function roots by controlling propagation steps.

1.1.2 Commands

RunSimulator GMAT includes components that are capable of generating simulated data. The Simulator, like all of GMAT's Solvers, implements a finite state machine. The Simulator's state machine works with the RunSimulator command to calculate expected measurement values and write these data to a measurement stream – typically a simulated observation file. In addition to these tasks, the command performs the usual tasks assigned to members of GMAT's Mission Control Sequence: checking for user actions such as hitting the stop or pause button, tracking the execution location in the Mission Control Sequence, and managing object changes induced by executing the command. In summary, the responsibilities of the RunSimulator command are:

- Collaborate with an simulator to run the finite state machine defining the simulation process.
- Perform initialization and finalization of the simulation processes.
- Perform standard GMAT command actions.

RunEstimator The RunEstimator command is used to tell GMAT to solve an estimation problem when events and maneuvers are not part of the estimation process. The user specifies an estimator for the problem, and the RunEstimator command and the estimator work together to find an estimate of state by executing the transitions in the estimator's finite state machine. Depending upon the current finite state for the state machine (for example, the state machine may be in the Initializing state or the Calculating state, or one of several other states defined for that specific Estimator), either the RunEstimator Command or Estimator will be driving the estimation process. The RunEstimator command also has basic housekeeping responsibilities required of all GMAT commands. These include checking for user actions such as hitting the stop button, tracking the execution location in the Mission Control Sequence, and managing object changes induced by executing the command. In summary, the responsibilities of the RunEstimator command are:

- Collaborate with an estimator to run the finite state machine defining the estimation process.
- Perform initialization and finalization of the estimation processes.
- Perform standard GMAT command actions

1.1.3 Helper Classes

MeasurementManager The measurement manager (MM) is a helper class for the Estimator and Simulator classes. It performs data management and interfacing between the Solvers and the measurement objects. A measurement manager has three areas of responsibility: sorting and bookkeeping observed values that may come from numerous files or data streams, calling the appropriate measurement object to determine computed measurement values and partial derivatives, and passing simulated data to the measurement stream objects for storage and later use. The Solvers do not communicate directly with the measurement objects; instead, the MeasurementManager mediates that communication. The measurement manager coordinates measurement information flow among all the measurement objects being used during an OD process. The MM calls the file reader for each data file and then sorts all observations into time-wise order. During the estimation process, the estimator calls the measurement manager and requests observed and computed values at the current epoch, as well as the measurement partials. The measurement manager then calls the appropriate measurement to determine the computed measurement value and the array of partial derivatives. During simulation, it reverses this process, calling the measurement objects to generate simulated observations, and then passing those data to the file writers. In summary, the measurement manager class has the following responsibilities:

- Book keep observed values from observation data files and sort the observation data in time order for use by the estimator.
- Provide the estimator with a time ordered array of measurement epochs.
- Provide the estimator with observed and computed measurement values, and partial derivatives at the current measurement epoch.
- Provide measurement weights to the estimator.
- Receives generated measurement data and passes it to a data file writer or other output data stream.

EstimatorStateManager The estimator state manager (ESM) retrieves state data from objects involved in estimation and provides the data in a form ready for use by the estimator. Hence, much of work performed by the ESM is getting and setting state data, including state transition matrix and covariance information, so that the estimator methods do not have to interact with all of the participant objects. For example, after an iteration (for Batch) or state update (for sequential), the ESM maps the new estimated state vector to the participating objects. Similarly, when an estimator needs the STM, the ESM retrieves the portions of the STM from the objects involved in estimation and assembles the complete STM and provides it to the Estimator. In summary, the responsibilities of the ESM class are:

- Get/Set state portions on objects involved in estimation and assemble the complete state vector.
- Get STM chunks from objects involved in estimation and assemble the total STM for the estimator.
- Get/Set state covariance chunks and assemble the entire covariance matrix.

File Reader/Writer The DataFile base class defines the methods and procedures to provide data accessibility to other GMAT components. These methods include being able to move from one data record to the next, as well as being able to request individual pieces of data without knowledge of a specific data format. The base class also provides general methods to appropriately handle the basic categories of data formats. The responsibilities of the file reader/writer class are

- Read all or part of a date file.
- Provide data of the requested type to the measurement object.
- Write simulated data to the requested file format.

PropagatorStateManager The propagation state manager (PSM) retrieves state data from objects involved in propagation and provides the data in a form ready for use by the propagator. Hence, much of work performed by the PSM is getting and setting state data. For example, after an integration step the ESM maps the state vector to the participating objects. Similarly, when a propagator needs the initial state vector, the PSM retrieves the portions of the state from the objects involved in propagation and assembles the complete state vector and provides it to the propagator. In summary, the responsibilities of the PSM class are:

- Get/Set state chunks on objects involved in propagation and assemble the complete state vector.

1.2 Collaboration between Classes

The design of the estimation system limits interactions between components, in order to promote loose coupling, a design principal used throughout GMAT. Below, we discuss which components can interact, and similarly, which components cannot interact.

There are three logical organizations of classes used in the orbit determination process:

- User configured resources
- Estimation commands
- Helper classes

Examples of resources include measurement participants (with attached sensors), measurements, propagators, and estimators. The helper classes include the EstimationStateManager (ESM), Propagation State Manager (PSM), the Measurement Manager (MM), and the Event Locator (EL). Currently, the only supported estimation commands are RunEstimator and RunSimulator.

Figure 1.1 contains an illustration all of the components involved in the estimation process, and shows which components can interact via arrows between the components. The interactions are discussed in more detail below.

Estimator -> ESM The ESM is an “owned-object” of an estimator. The estimator interacts with the ESM to get/set state related data from/on estimation participants. The estimator communicates with the ESM through several interfaces depending upon the type of state data such as STM, covariance, or state vector.

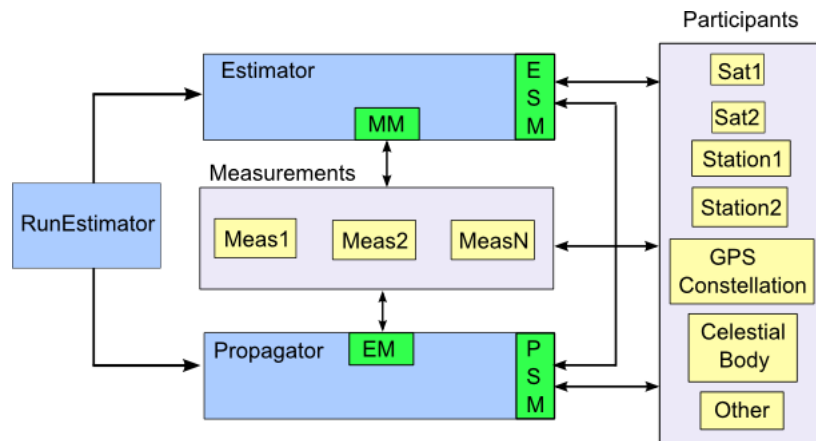

Figure 1.1: OD Components and Interactions

ESM ->Participants The ESM communicates with participants to set and get state related data.

Measurements->Participants Measurements communicate directly with measurement participants/sensors. Measurement objects have pointers to all measurement participants in the measurement and therefore have direct access to public state data required to calculate measurement values and partial derivatives.

PSM -> Participants The PSM communicates with participants to set and get state related data. This interface is similar to the ESM->Participants interface, except the PSM and ESM may not manipulate the same state data.

ESM -> PSM The PSM and ESM interact during initialization. The ESM provides the PSM with a list of objects and IDs that are involved in the estimation process. The PSM uses this information to determine which states require propagation, and how those states should be propagated (analytically or numerically). In terms of the component level design, the PSM uses the data provided by the ESM to generate the ListItem structure discussed in detail in the Component Design section.

RunEstimator -> Propagator The RunEstimator command communicates with the propagator to perform initialization and to propagate estimation participants.

RunEstimator -> Estimator The Estimator and the RunEstimator command function as a finite state machine. This is a complex interaction described in detail in later sections.

MM -> Measurements The measurement manager interacts with measurements during initialization and execution. During initialization, the measurement manager calls each measurement object's Initialize() method and calls its GetObsData() method to get the arrays of epochs, observations, and pointers to the measurement data objects. During execution, the measurement manager calls the Evaluate() and GetPartials() methods on the measurement object.

Estimator -> MeasurementManager The estimator interacts with the measurement manager to get computed measurement values and partial derivatives and other measurement related information.

1.3 Walkthrough of Sample Script Execution

In this the remainder of this chapter, we present a simple estimation example in script form and show at an intermediate level how GMAT would load and execute the script. The first subsection contains the sample script. The next subsection contains a general discussion of the steps GMAT uses to execute any script. We identify six key areas in the execution process that must be addressed in the design of new estimation components and conclude the section with a more detailed discussion of what happens for the new estimation components in those six key areas. The design for the objects used in this example are contained in the later chapters of this document.

1.3.1 The Sample Script

The sample script used for the execution walk-through has 5 objects: a spacecraft named ODSat, a ground station called Maui, a batch estimator called BLS, a measurement object named MauiData, a propagator named ODprop, and a RunEstimator command. The system processes range measurements between Maui and ODSat using a batch least squares estimator. The solve-for states are the Cartesian states of the spacecraft.

```

%=====
%----- Define the spacecraft properties
%=====
Create Spacecraft ODSat;
ODSat.Id      = 21639;
ODSat.Epoch   = 24228.72771990741;
ODSat.X       = 9882.164071524565;
ODSat.Y       = -23;
ODSat.Z       = 1837.579337039707;
ODSat.VX      = 0;
ODSat.VY      = 6.233189510799131;
ODSat.VZ      = 0.8480529946665489;
ODSat.OrbitCovariance = diag([100000^2*ones(3,1);1000^2*ones(3,1)]);

%=====
%=====
%----- Define the batch least squares solver
%=====
%=====
Create GroundStationMeasurement MauiData;
MauiData.Filename      = 'LEOMaui.mat';
MauiData.AddDataType = {'Range','ODSat','Maui'};

%=====
%----- Define the batch least squares solver
%=====
%=====
Create BatchEstimator BLS
BLS.MaxIterations      = 10;
BLS.RelTolerance       = 1e-5;
BLS.AbsTolerance       = 1e-5;
BLS.Measurements       = {'MauiData'};
BLS.SolveFor           = {'ODSat.CartesianState'};
BLS.Propagator         = 'ODProp';

```

```

%=====
%----- Define the ground station properties
%=====
Create GroundStation Maui;
Maui.Id = 222;
Maui.X = -4450.8;
Maui.Y = 2676.1;
Maui.Z = -3691.38 ;

%=====
%----- Define the Propagator
%=====
Create ForceModel ODProp_ForceModel;
GMAT ODProp_ForceModel.CentralBody = Earth;
GMAT ODProp_ForceModel.PointMasses {Earth};

Create Propagator ODProp;
GMAT ODProp.FM = ODProp_ForceModel;
GMAT ODProp.Type = RungeKutta89;
GMAT ODProp.InitialStepSize = 60;
GMAT ODProp.Accuracy = 9.999999999999999e-12;

%=====
%----- Solve the estimation problem
%=====
RunEstimator BLS;
    
```

1.3.2 Overview of a GMAT Run

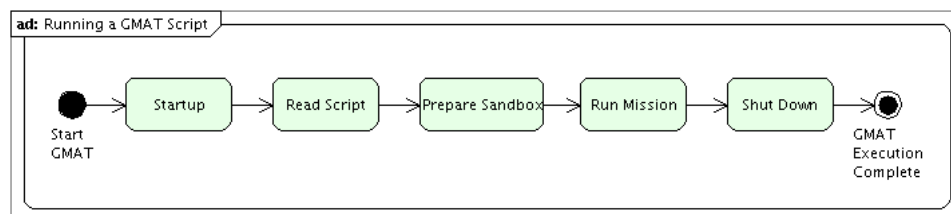

Figure 1.2: GMAT Run Overview – Running a Script

Figure 1.2 shows a high level view of the path through a run of a GMAT script. When a user wants to run a GMAT script, she starts by opening the program, launching a set of actions that prepare the system for a run. Once this startup process is complete, she loads the script into memory. This script reading process creates the resources described in the script, loading them into GMAT’s configuration (the container GMAT uses for objects created when building the resources in a script or from the GUI), and builds the commands in the Mission Control Sequence. Next the objects are loaded into the Sandbox, and the Sandbox is prepared to perform the run by initializing all of the objects that were loaded. The mission is run, executing the scripted sequence of commands. Finally, the user closes the program, completing the process.

Figure 1.3 shows a first level expansion of these steps. The details of the steps shown in that figure can be found in the Architectural Specifications. The blocks that are affected by the new estimation components

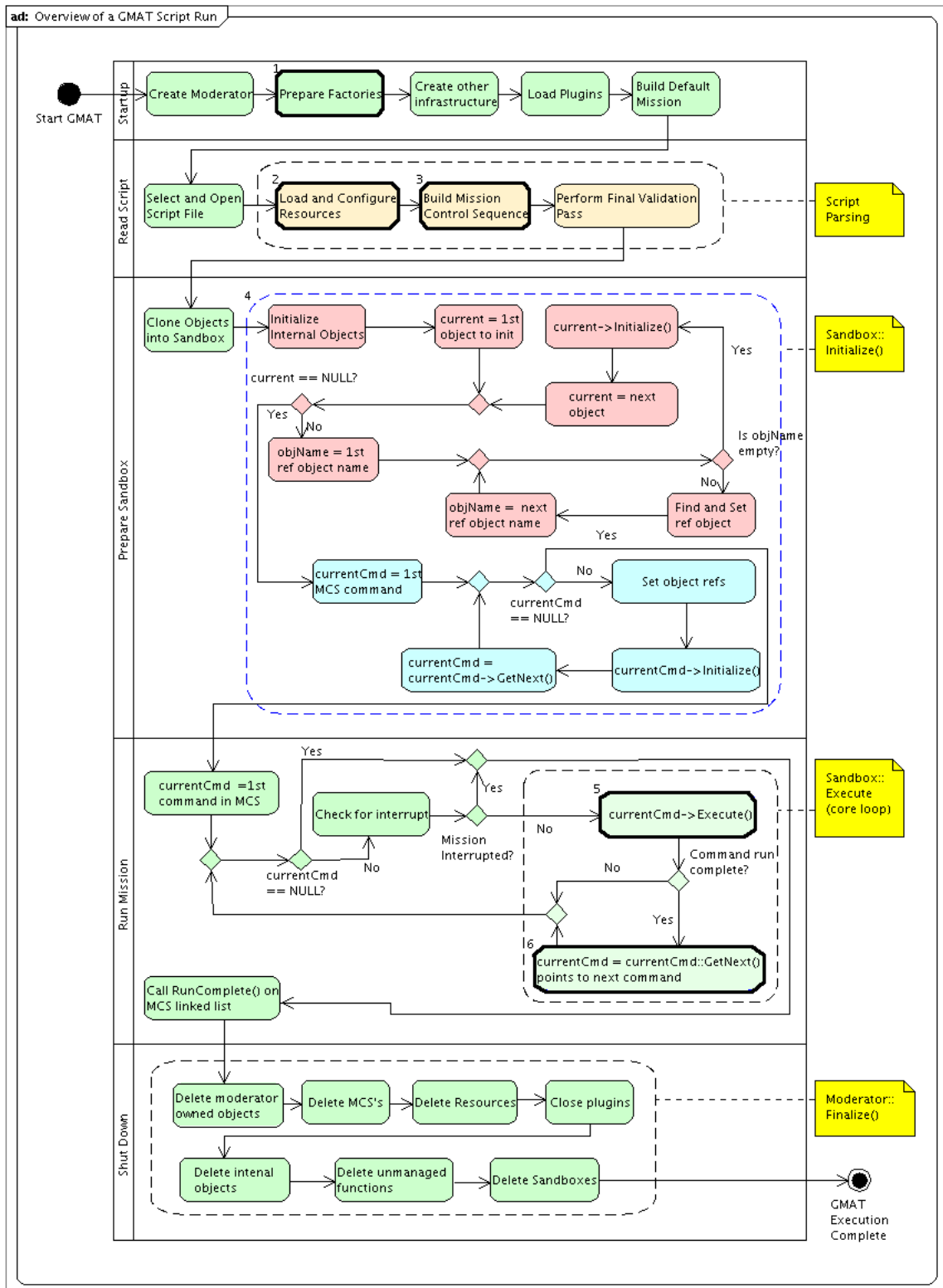

Figure 1.3: GMAT Run Overview – Top Level Action Details

are numbered in the diagram, and will be discussed in more detail in this document. There are six blocks that will be discussed here:

1. **Prepare Factories** GMAT uses a set of components, called factories, to create resources, commands for the Mission Control Sequence, and parameters used in calculations during a mission run. New factories will be built to handle the new resources required to run estimation problems in GMAT.
2. **Create and Configure Resources** When GMAT parses a script, it reads the file one line at a time, building the scripted objects and setting their parameters. Depending on the resource, the parameter setting phase may also include the creation and setting of objects owned by the resource.
3. **Build Mission Control Sequence** Following the resource definition and configuration steps, the script describes the mission using a sequence of commands tailored to the components supported by GMAT. This sequence of commands is assembled into a linked list of objects called the Mission Control Sequence.
4. **Prepare Sandbox** GMAT runs missions inside of a component called the Sandbox. When a mission is run, the resources and Mission Control Sequence are loaded into the Sandbox used for the run, interconnections between the components are established, and any pre-run data is set on these components. At the end of this process, the Sandbox is ready to execute the Mission Control Sequence.
5. **Execute()** Commands in the Mission Control Sequence manipulate the resources in the Sandbox through a call to the Execute() method on each command in the sequence.
6. **GetNext()** GMAT walks through the Mission Control Sequence by accessing the members of the sequence's linked list. Movement through the list is performed using the GetNext() method.

These above six portions of a GMAT run are particularly relevant to the new estimation components. The remaining blocks in the diagram may be discussed in passing, but the focus of the descriptions necessary to build the pieces GMAT needs will include discussion of these six elements in more detail.

The sample script presented earlier contains five resources and a command: a Spacecraft named ODSat, a Measurement named MauiData (which contains two owned data members, a MeasurementReader and a GroundstationRange MeasurementData object), a BatchEstimator named BLS, a GroundStation named Maui, a Propagator named ODProp (with an owned ForceModel), and a RunEstimator command. The estimator contains a MeasurementManager and an EstimationStateManager as member objects. Similarly, the propagator contains instances of a PropagationStateManager and an EventLocator. Each of the following sections will conclude with a table reporting the status of GMAT and each of these six objects after the process described in the section has acted on the sample script. Prior to launch of the system, the system description table looks like this:

GMAT Status Before Starting the Program		
The program has not yet started		
<i>Object</i>	<i>Status</i>	<i>Notes</i>
ODSat	Not yet created	
MauiData	Not yet created	
BLS	Not yet created	Once built, includes an EstimationStateManager and a MeasurementManager as members
Maui	Not yet created	
ODProp	Not yet created	Once built, includes a PropagationStateManager and an EventLocator as members
RunEstimator	Not yet created	

1.3.3 Script Execution Walkthrough

1.3.3.1 Block 1: Prepare Factories

GMAT's Factory subsystem is used to create all scriptable components of the system. The subsystem is an implementation of the Abstract Factory design pattern: it defines the interfaces used for creating user objects and Mission Control Sequence commands, and uses derived Factory classes to provide the implementation for specific class instantiations. The Factory subsystem is managed by a singleton instance of the FactoryManager class. The Moderator calls methods on the FactoryManager to create instances of specific types of objects, identified by the name of the object's type: Spacecraft, GroundStation, DifferentialCorrector, and so forth. Similarly, the Moderator calls the FactoryManager to create instances of GMAT's command classes in order to build the Mission Control Sequence.

Each Factory supporting user objects is registered with the FactoryManager when GMAT starts up. The internal factories are registered first, followed by factories contained in plug-in libraries. The addition of estimation capabilities to GMAT necessitates the construction of factories supporting the new types of objects that are used for estimation, along with registration of these new factories with the FactoryManager. The "Prepare Factories" block of the master overview diagram (Figure 1.3) identifies the location of the factory registration in the life cycle of a GMAT run.

Estimation requires the construction of five (check this) new factories for the internal capabilities being designed here. These new factories are:

- **EstimatorFactory** The Factory that creates GMAT's internal estimators. These components could be added directly to the SolverFactory, since all Estimators are Solvers. The inclusion of a new factory for the Estimator objects keeps the factory subsystem more modular, and will allow for inclusion of the estimation capabilities as a plug-in if desired.
- **MeasurementFactory** Measurement objects, a new class of object in GMAT, require a new Factory supporting their instantiation. The Measurement objects include elements that define data types for the measurements and sources for observation data. Separate factories are provided for these elements.
- **MeasurementDataFactory** Creates the measurement data objects. The measurement data objects are used to calculate the expected value of a specific type of measurement along with the partial derivatives associated with that value.
- **ObservationReaderFactory** Creates the objects used to read and write observation data. The observation data may be fed into GMAT from a data file, a database, or by means of a live data feed. The initial builds of GMAT's estimation subsystem are designed to work using data from a file.
- **EstimationCommandFactory** Creates the commands used in estimation. The inclusion of a new factory for the estimation commands objects keeps the factory subsystem more modular, and will allow for inclusion of the estimation capabilities as a plug-in if desired.

The Moderator creates these factories during system start². Each factory is passed to the FactoryManager once it is created. The FactoryManager obtains the base type of the objects supported by the factory along with a list of the supported types. For example, in the initial estimation release, the MeasurementDataFactory will report that it supports the Gmat::MEASUREMENT_DATA type, and can supply specific objects for "GroundStationRange", "GroundStationRangeRate", "GroundStationRADec", and "GroundStationAzEl" measurement data.

The factories identified above will be described in more detail in the class descriptions. These factories follow the same pattern as is found in the rest of GMAT. There are no special considerations imposed on the system by the inclusion of the estimation related factories.

²Internal and plug-in factories are constructed and registered in the Moderator's initialization code. The Estimation code is built as a plug-in module, and as such, is loaded into the system by loading the library at run time after all of the internal Factory objects have been loaded.

Several new base object types will be added to GMAT to support estimation. Specifically, new types will be added to support Measurement classes, MeasurementData classes, and ObservationReader classes. (The Estimator classes are already handled through inheritance from the Solver base class.) The Factory base class and Gmat namespace will be extended to include these new types.

The following table shows the configuration of GMAT and the state of each of the objects contained in the sample script after the factory registration phase is complete.

GMAT Status After Preparing Factories		
This step prepares the elements of GMAT's engine that are needed to build the resources and commands in a GMAT script. All of the factories have been created and registered with GMAT's FactoryManager. GMAT is essentially idle, waiting for a user prompt to begin processing. The GUI versions of GMAT complete the system startup by building the default mission.		
<i>Object</i>	<i>Status</i>	<i>Notes</i>
ODSat	Not yet created	
MauiData	Not yet created	
BLS	Not yet created	
Maui	Not yet created	
ODProp	Not yet created	
RunEstimator	Not yet created	

1.3.3.2 Block 2: Load and Configure Resources

The objects users configure in GMAT fall into two categories: Resources and Commands. The elements that define the time ordered sequence of actions in the Mission Control Sequence fall into the latter category, and are discussed in the Block 3 description below. The elements that identify the physical objects and tools that manipulate those objects are called resources. These components include the Spacecraft; Groundstations; hardware elements (tanks and thrusters); celestial bodies and special locations in the solar system; variables, arrays, and strings; targeters, optimizers, and estimators; and other elements that act as items used when defining the mission timeline. In the GUI versions of GMAT, these pieces are located on the Resources tree, while the commands appear on the Mission tree.

GMAT's script processing subsystem operates in two distinct modes: object mode and command mode. The resources are created and configured in object mode, prior to the definition of the Mission Control Sequence. As soon as a command for the Mission Control Sequence is encountered, the ScriptInterpreter changes from object mode into command mode. Each subsequent line of the script file is treated as a node in the control sequence, and placed into the linked list defining the Mission Control Sequence.

Block 2 in the master overview diagram represents the actions taken by the ScriptInterpreter in object mode. In this mode, GMAT creates resources, saves them for later use, and sets parameters on created resources. Resources are built from script lines that start with the GMAT keyword "Create". When the ScriptInterpreter finds a line starting with that keyword, it takes the next word in the line as the text describing the type of object requested, and the remaining words as the names of objects of the specified type that need to be constructed. The ScriptInterpreter passes the request for each new object to the Moderator, which passes the request into GMAT's FactoryManager. The FactoryManager locates the factory responsible for creating the requested object type, and passes the creation request into that factory. The factory creates the requested object, assigning it the specified name, and returns the new object's pointer to the Moderator. (If no object was created, the returned pointer is NULL.) The Moderator passes the object into the ConfigurationManager so that the new object can be stored for later use (objects managed this way by the ConfigurationManager are referred to as "configured objects"), and then returns the pointer to the ScriptInterpreter.

Assignment lines – that is, lines of the form "object.parameter = value" – encountered in object mode make calls directly into the configured objects, setting values on those objects. This parameter setting

identifies values used by the objects, sets the identities for references the objects use, and in some instances sets up owned objects that the configured objects need. If an object uses a reference to another configured object, the name of the referenced object is stored as a string in the object that uses the reference so that the object pointer can be set during initialization in GMAT's Sandbox. For example, when the script line "BLS.Propagator = ODProp;" is parsed, the BLS estimator is sent the string 'ODProp'. The BLS propagator stores that string name for use during the "Prepare Sandbox" phase to identify the propagator object that the estimator needs.

Most of the object parameter setting needed by the estimation resources fall into the category of parameter values and references set by object name. Discussions for this type of parsing will not be presented in detail in this document for all of the estimation components. The components that use owned objects will contain information detailing the creation and configuration of those objects. In particular, the Measurement objects own MeasurementData objects and ObservationReader objects in order to provide calculated and observed data and derivative information to the estimation process. The management of these elements will be discussed in the class descriptions below.

GMAT Status After Creating and Configuring Resources		
The resources defined in the script have been created, and all of the object properties defined for these resources have been set. Internal ("owned") objects defined for the resources have been created and set on the resources. The next script line that is read describes the first command in the Mission Control Sequence. It will toggle the ScriptInterpreter out of object mode and into command mode.		
<i>Object</i>	<i>Status</i>	<i>Notes</i>
ODSat	Created, Properties Set, Uninitialized	Scripted data values have been set.
MauiData	Created, Properties Set, Uninitialized	The owned ObservationReader and GroundstationRange objects have also been created and passed to MauiData. The file handle for the ObservationReader has not yet been opened.
BLS	Created, Properties Set, Uninitialized	Scripted data values have been set. The names of reference objects are set. The pointers to the reference objects are all NULL. The BLS MeasurementManager and EstimationStateManager are created as part of the estimator, but not initialized. The EstimationStateManager and MeasurementManager objects have been created as object members. Neither contains any data.
Maui	Created, Properties Set, Uninitialized	Scripted data values have been set.
ODProp	Created, Properties Set, Uninitialized	Scripted data values have been set. The ODProp PropagationStateManager and EventLocator have been created as part of the propagator, but not yet initialized.
RunEstimator	Not yet created	

1.3.3.3 Block 3: Build Mission Control Sequence

Resources in GMAT are built by the ScriptInterpreter running in object mode. As soon as GMAT finds a Mission Control Sequence command in the script file, it toggles into command mode, and remains in that mode until the script has been fully read. Commands in GMAT can be interpreted in one of two different ways. Commands that are scripted using a simple series of strings with no specialized elements follow this format:

commandKeyword [element1 ...]

(The formatting here is that optional elements lie in square brackets, and ellipses indicate additional pieces matching the one preceding the ellipses. If a selection is necessary between several options, the choices are separated by a vertical bar.) Commands formatted this way can be handled directly by the ScriptInterpreter. Commands that have more specialized syntax override the GmatCommand::InterpretAction() method and provide customized parsing for the line of text defining the command.

The estimation commands planned for the initial releases of GMAT's new capabilities, RunEstimator and RunSimulator, fall into the former category. These commands are passed a single command parameter and possibly a mode string defining the mode of operation. Details about the syntax for each of these commands can be found in the descriptions of the command classes, later in this document.

GMAT Status After Building the Mission Control Sequence		
This step completes the script reading phase of the Interpreter's work. All that remains is the final pass through the objects to validate a few settings and to ensure that all of the objects needed to run actually do exist in the ConfigurationManager's object container.		
Object	Status	Notes
ODSat	Created, Properties Set, Uninitialized	
MauiData	Created, Properties Set, Uninitialized	
BLS	Created, Properties Set, Uninitialized	
Maui	Created, Properties Set, Uninitialized	
ODProp	Created, Properties Set, Uninitialized	
RunEstimator	Created, Properties Set, Uninitialized	The referenced Estimator, ODProp, is identified by name. The pointer is not set.

1.3.3.4 Block 4: Prepare Sandbox

GMAT runs scripts in an instance of a specialized container class called the Sandbox. The process of running a script is performed in two phases: Sandbox Initialization and Sandbox Execution. The initialization phase consists of four steps, shown in Figure 1.4.

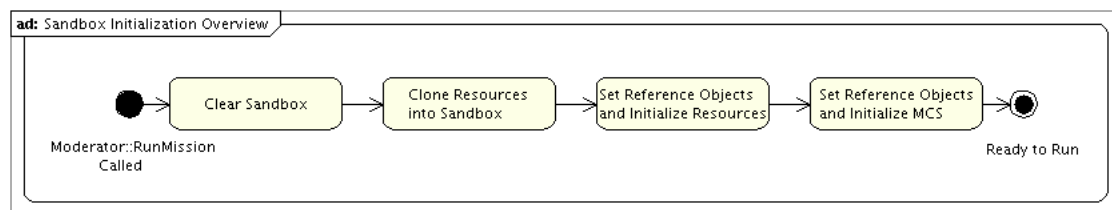

Figure 1.4: Steps if the Sandbox Initialization Process

First, the Sandbox is instructed to clear its data structures in case there are objects in the Sandbox from a previous script execution. Next, all of the resources managed by the ConfigurationManager are copied into the Sandbox. The original configured objects are not moved into the Sandbox; instead, the Sandbox makes a copy of each object for local use in the Sandbox, using each resource's Clone() method. The Mission Control Sequence is also passed into the Sandbox at this time; the Mission Control Sequence is not cloned.

Once all of the resources have been cloned into the Sandbox, the Sandbox's Initialize() method is called. This method initializes the resources and commands for use in the mission run. The Sandbox performs this initialization of resources in an ordered fashion, ensuring that more basic resources are initialized before the components that use them are initialized³. The resource initialization is performed one object at a time. Resource initialization consists of three steps: (1) the Sandbox retrieves a list of objects referenced by the object that is being initialized, (2) each object in the list of references is located and passed by pointer to the object being initialized, and (3) the object's Initialize() method is called.

Steps (1) and (2) described here are illustrated in the system specifications[ArchSpec]. The Sandbox contains two object containers: the objectMap containing objects specific to the Mission Control Sequence but not automatically visible to functions in the control sequence, and the globalObjectMap containing objects visible to all commands in the Sandbox, including those in function calls. This object scoping complexity is managed as part of the Sandbox initialization process.

Objects in GMAT may contain object references that are accessed in one of two ways. Objects with a single referenced object provide the Sandbox with the name of that object through a call to the GetRefObjectName() method. Objects that reference multiple references provide a StringArray of reference objects names through a call to the GetRefObjectNameArray() method. The calls made in the Sandbox to access these two methods are also shown in Figure 1.5.

After all of the resources have been initialized, the Sandbox initializes the Mission Control Sequence. Control sequence initialization is performed one command at a time, using a pointer to the current command being initialized. This process is performed in three steps. First, the current command is passed a pointer to the solar system used in the Sandbox, the internal object pointers, and the arrays of the resources that were cloned into the Sandbox. Once the command has these pointers set, it initializes itself through a call to its Initialize() method. Finally, the current command pointer is updated to point to the next command that needs initialization through a call to the GetNext() method.

Sandbox initialization is the most complicated phase of a mission run in GMAT. Because of this complexity, the initialization steps required for each of the new estimation objects will be described in the class descriptions below.

GMAT Status After Preparing the Sandbox for the Run		
Mission runtime copies of all resources and commands have been passed into the Sandbox. Each resource has had its references to other resources set. The Mission Control Sequence has been passed the local and global object stores (named objectMap and globalObjectMap in the code), and used these structures to locate and set pointers to the objects used by each command in the sequence. GMAT is ready to run the mission.		
<i>Object</i>	<i>Status</i>	<i>Notes</i>
ODSat	Created and Initialized	All resources here are clones of the configuration manager's objects. Pointers to the referenced objects have all been set.
MauiData	Created and Initialized	
BLS	Created and Initialized	
Maui	Created and Initialized	
ODProp	Created and Initialized	
RunEstimator	Created and Initialized	The pointer to the estimator has now been set.

1.3.3.5 Block 5: Execute() and Block 6: GetNext()

Upon completion of the Prepare Sandbox step described above, all of the pointers connecting the objects together for the mission run have been set, and each element of the run has been given the opportunity to perform its initialization. The commands in the Mission Control Sequence have all been passed pointers to

³Resource initialization is actually handled in an instance of the ObjectInitializer class in the Sandbox. The ObjectInitializer manages the ordered initialization process, which is performed as described here.

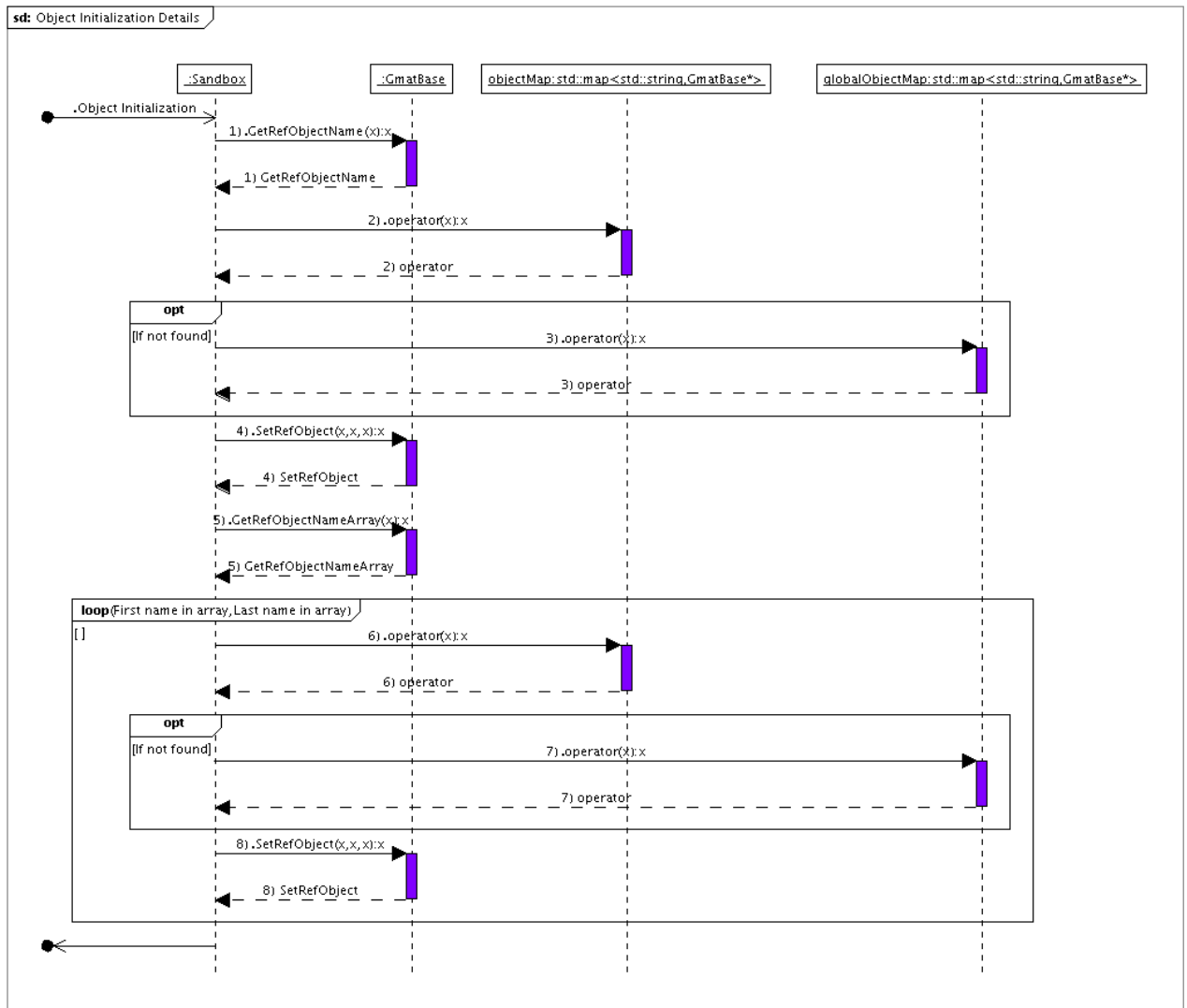

Figure 1.5: Reference Object Setting during Initialization

the objects used to run the mission, and have been given the opportunity to perform their initialization. The Mission Control Sequence is ready to run the mission.

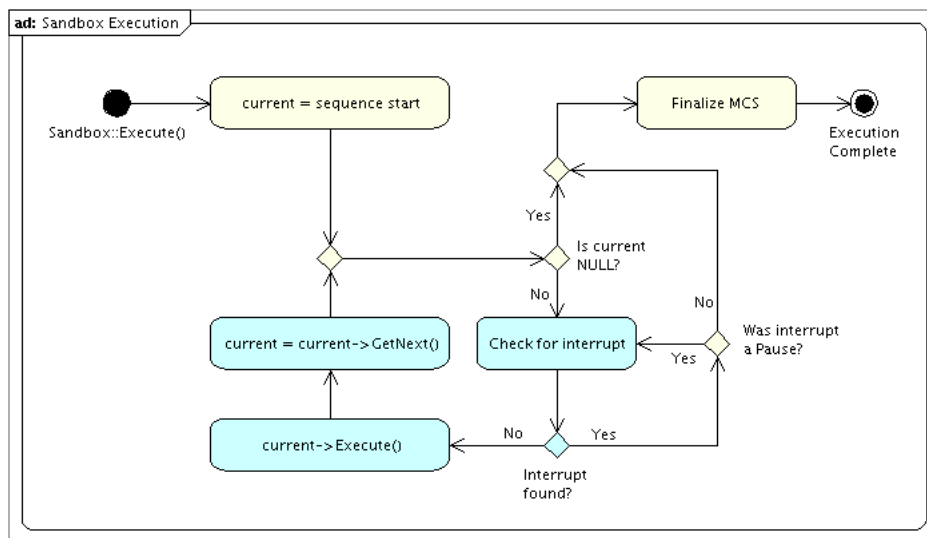

Figure 1.6: The `Sandbox::Execute()` Method

Figure 1.6 shows the process GMAT follows when executing the Mission Control Sequence. The Moderator launches the run through a call to the Sandbox's `Execute()` method. That method sets a pointer to the first command in the Mission Control Sequence. If that pointer is not NULL, the Sandbox then places a callback to the Moderator to see if a user interrupt (typically a request to stop or pause the control sequence execution) has occurred. If there is no interrupt, the command's `Execute()` method is called. The command performs its processing, and returns control to the Sandbox. The Sandbox then calls the command's `GetNext()` method, setting the command pointer to the next command that needs to be executed in the Mission Control Sequence. If that pointer is not NULL, the Sandbox makes a callback to the Moderator to see if a user interrupt has occurred, and the process repeats. The run ends when the command pointer is set to NULL. At that point, each command in the Mission Control Sequence is given the opportunity to finalize itself, and then control is returned to the Moderator, completing the run.

One subtlety in this process is the interplay between calls to a command's `Execute()` and `GetNext()` methods. Some commands in GMAT – particularly those that perform propagation and those that manage logical branching in the control sequence – consume more computational time than desired before checking for user interrupts. The implementation of the `Execute()` and `GetNext()` methods for these commands is designed to allow for interruption and reentry to the command so that interrupt checking can be performed while the command is executing. At select times during execution of these commands, the process is paused and control is returned to the Sandbox. The call to the `GetNext()` method in these cases returns a pointer to the executing command, rather than the next command in the Mission Control Sequence. After the Sandbox performs the interrupt check, the command is called and execution resumes at the point where it was paused.

The commands that govern estimation – specifically the `RunEstimator`, `RunSimulator`, and `Estimate` commands – described in this document all exhibit this reentrant interrupt behavior. The descriptions of those commands in the following sections include descriptions of this implementation in the descriptions of the execution process for the commands.

GMAT Status After Calls to Execute() and GetNext() are Complete		
GMAT has completed the run. Each command in the Mission Control Sequence has been executed, with the possible exception of conditional branches that may have been skipped. Command Summary data is available for each executed command. The objects in the Sandbox have been used as dictated by the contents of the Mission Control Sequence.		
<i>Object</i>	<i>Status</i>	<i>Notes</i>
ODSat	Created and Exercised	Sandbox version of the ODSat object contains the results of the estimation process
MauiData	Created and Exercised	
BLS	Created and Exercised	
Maui	Created and Exercised	
ODProp	Created and Exercised	
RunEstimator	Executed Once	The command has been executed. If the tracking data is suitable, the estimator has run to completion and converged on a solution, which has been fed back into the resources in the Sandbox.

Draft for Release 2011a Beta

Part II

Estimation Components

Draft for Release 2011a Beta

Chapter 2

The Estimators and Simulator

Stephen P. Hughes
NASA/Goddard Space Flight Center

Darrel J. Conway
Thinking Systems, Inc.

Matthew P. Wilkins
Schafer Corporation

GMAT's Estimator classes are shown in Figure 2.1. The first estimator build of GMAT includes the blocks shaded orange and the BatchLeastSquares based estimator to

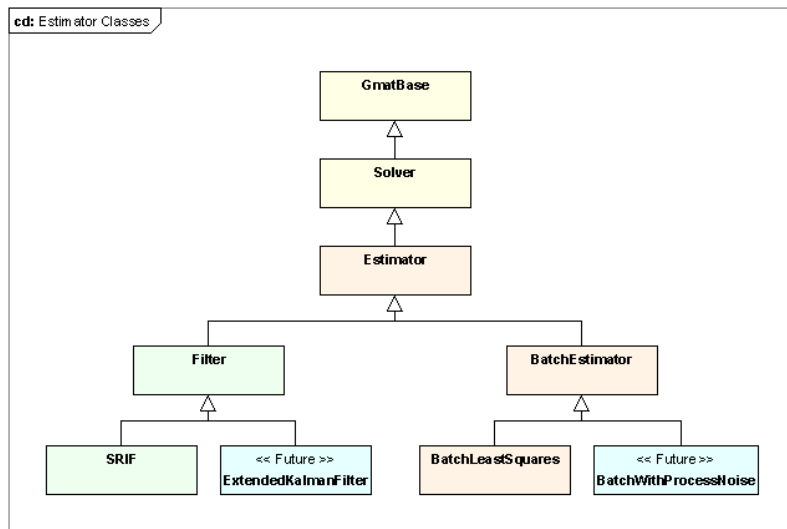

Figure 2.1: Classes in GMAT's Estimator Hierarchy

GMAT's Estimator base class defines the core functionality shared by all estimators. It includes the top level Estimator interfaces, initialization code for the shared elements including the EstimationStateManager and MeasurementManager, and the member components implementing these elements. The interfaces in this class are defined so that the estimation commands can treat the estimator process generically, and therefore drive the estimation process without intimate knowledge of the algorithm that is implemented in the estimator.

GMAT's estimator classes are derived from the Solver base class. The Solver class provides data structures and methods designed so that derived classes can implement a finite state¹ machine that, together with a matching command, organizes the process of working with the elements of the a GMAT mission to drive the algorithm implemented in the solver. The command portion of this partnership manages the interface with the Sandbox and the propagation subsystem, and, when appropriate, with a solver control sequence designed to provide a sequence of commands when that sequence involves more than just direct propagation. The solver side of the partnership manages the state of the solution algorithm. That state is represented by one of several distinct values; hence the state machine is called a finite state machine. The command side retrieves the state if the state machine from the solver, performs any necessary control sequence actions, and then passes control to the solver so that the solver can evaluate and potentially change state based on the results of the command's actions.

The state machine in GMAT's solvers provides a mechanism to ensure that the control sequence is executed in a sensible manner for the implemented algorithm. As such, each derived solver class will define its state machine to meet the needs of its algorithm. The state machines for each of the new estimators are described in the corresponding class descriptions below.

The following sections describe each estimation class in the figure, starting with the Estimator base class. The capabilities and member elements are described, along with the processes that each class implements.

2.1 The Estimator Base Class

The Estimator class contains two key member objects used by all of GMAT's estimators: an instance of the EstimationStateManager and an instance of the MeasurementManager. The details of those classes are provided in the corresponding sections of this document. In this section you will see how these objects are set up and used by the Estimator classes.

Figure 2.2 shows the Estimator class, its ancestors, and its predecessor. The details of the class contents are shown in this figure, along with the helper classes mentioned above. The Estimator class centralizes the interfaces to the measurement data and the estimation state vector, along with the other elements that all estimators need. This class extends the features of the Solver class by adding and initializing these new elements. As a base class, we anticipate that the implementation process for the derived estimators will result in a fair amount of refactoring, particularly as the BatchEstimator and Filter classes are implemented, consolidating additional common estimation features.

2.1.1 Key Processes

The Estimator base class has one key process: the Initialize method, which initializes its management members and prepares its propagation subsystem for initialization.

2.1.1.1 Estimator Initialization

The Estimator class manages the initialization of the EstimationStateManager and the MeasurementManager, along with preparation of the PropagationStateManager for initialization, as is shown in Figure 2.3. The Estimator::Initialize() method calls the Solver::Initialize() method first to ensure that the Solver data structures are properly prepared for use. Following this call, the EstimationStateManager::Initialize() method is called, which sets the data structures for the estimation state vector and then builds the vector. Once the estimation state vector has been built, the Estimator walks through the estimation state vector and passes each element that needs propagation into the PropagationStateManager assigned to the Estimator's propagator. This process prepares the propagation subsystem for initialization, but does not perform the actual initialization. That call is made in the estimation command immediately prior to execution so that all

¹"State" in the context of a finite state machine corresponds to the status of the machine. This is distinct from the state vector used by an estimator or SpaceObject. When the context does not make the distinction clear, the term "finite state" is used for the state machine states and "state vector" for the data.

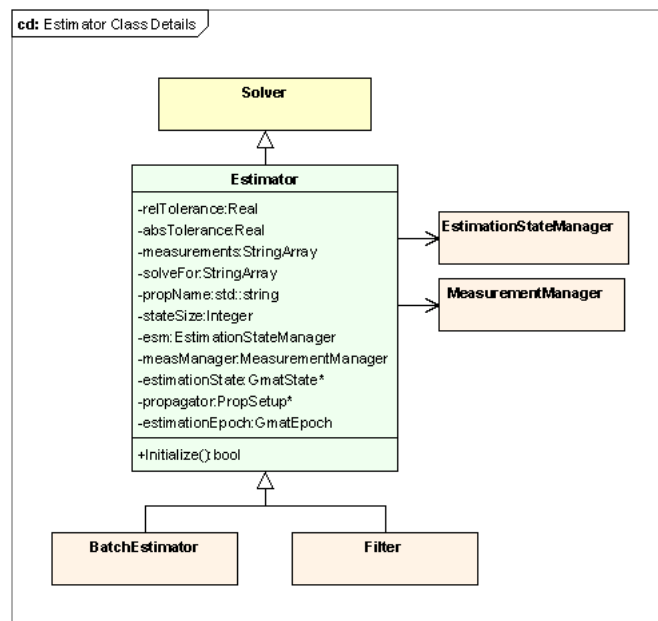

Figure 2.2: The Estimator Class

transient forces required for the propagation can be managed. Finally, the `MeasurementManager::Initialize()` method is called, causing the measurement manager to read all of the data available for processing and to build the structures needed for that processing. This step completes initialization for the Estimator base class.

2.1.2 Estimator Members

Estimator Attributes

- **Real relTolerance:** The maximum change from the previous RMS error in the residuals to the current RMS error allowed in order for convergence to be met. **Real absTolerance:** The largest allowed change in the estimation state in order for convergence to be met. **StringArray measurements:** Names of the measurement types used in this estimator. This array of names is passed to the `MeasurementManager` for processing. **StringArray solveFor:** List of the solve for parameters used in the estimator. **std::string propName:** Name of the configured propagator used to evolve objects during the estimation process. **Integer stateSize:** The size of the estimation state vector. **EstimationStateManager esm:** The `EstimationStateManager` for the estimator. This member is responsible for the communications between GMAT's objects and the data structures manipulated by the estimator during the estimation process. **MeasurementManager measManager:** The `MeasurementManager` for the estimator. This object is responsible for managing all of the measurement objects in the estimation process. It is an intermediary responsible for retrieving observed and calculated data, and supplying those data to the estimator. **GmatState *estimationState:** A pointer to the estimation state managed by the `EstimationStateManager`. This pointer is set after the `EstimationStateManager` is initialized. It is provided for convenience, so that repeated calls to `esm.GetState()` are not needed in the code. **PropSetup *propagator:** The propagator configured for the estimation. **GmatEpoch estimationEpoch:** The estimation epoch. For batch estimators, this epoch is the epoch of the state estimate. For sequential epochs, it tracks the epoch of the current estimate.

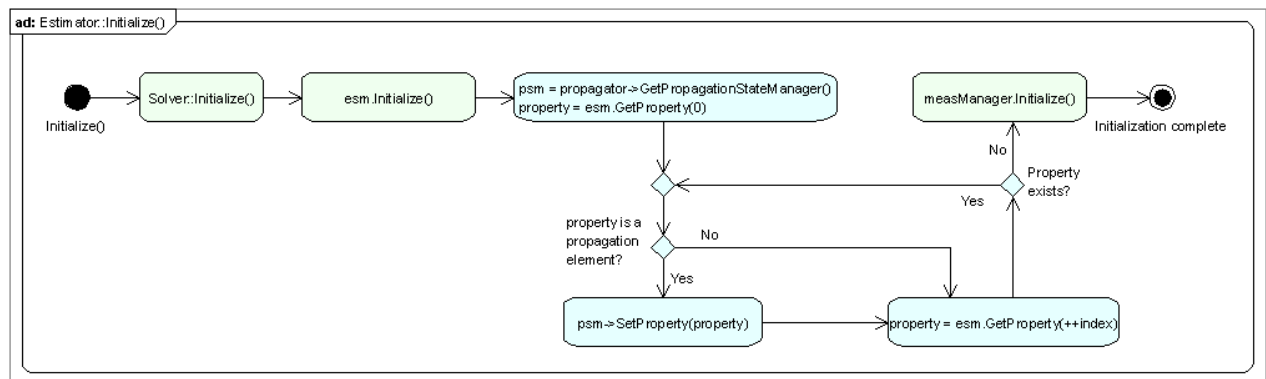

Figure 2.3: Estimator Class Initialization

Estimator Methods

- **bool Initialize():** Prepares the EstimationStateManager and MeasurementManager for use in estimation, and loads the propagator's PropagationStateManager so it can be initialized by the propagation enabled commands.

2.2 The BatchEstimator Class

The BatchEstimator class, shown in Figure 2.4, implements the infrastructure used by GMAT's batch estimators. This infrastructure includes the implementation of a state machine intended to support the usual sequence of actions needed for batch estimation. The class defines with the methods called from this state machine, and provides implementations of the methods that are considered to be common to the batch estimation process. All of the common methods implemented for the BatchEstimator class are declared virtual. Derived classes can override the estimation state machine or any of the implemented methods as needed to support algorithm specific needs. The Accumulate(), Estimate(), and CheckCompletion() methods are considered to always be implementation specific, and therefore must be implemented in the classes derived from the BatchEstimator class.

2.2.1 Key Processes

The BatchEstimator class implements a basic finite state machine that follows a typical batch estimation process. There are two processes that work together to implement the state machine: initialization of the BatchEstimator and execution of the finite state machine.

2.2.1.1 Initialization

The initialization process in the Sandbox starts with the object setting phase described in the GMAT run overview. At the end of this phase, all of the references objects have been set on the BatchEstimator object, and it is ready to validate those objects and set the pointers for use in the estimation process. This process is shown in Figure 2.5.

The initialization process for the BatchEstimator starts by initializing the Estimator base class as described above. Once that process completes successfully, the data structures required for accumulation are prepared. Finally, the initial data are checked to be sure that they contain all of the required data, and that

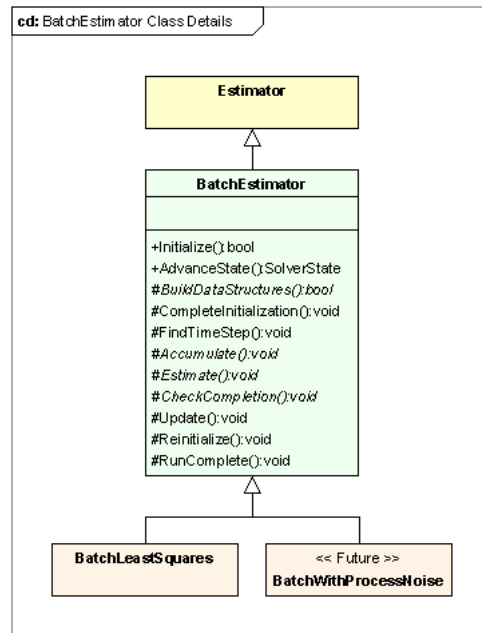

Figure 2.4: The BatchEstimator Class

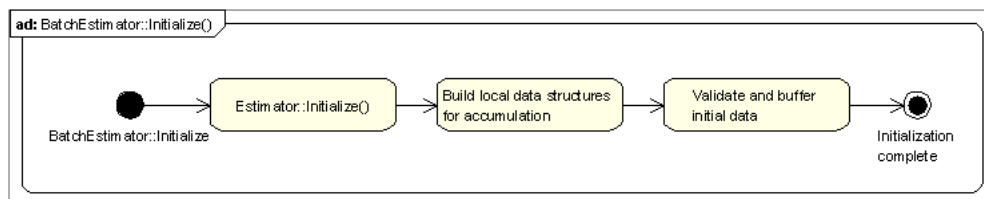

Figure 2.5: Initialization in the BatchEstimator Class

these data are internally consistent, and they are buffered so they can be restored during iteration. This completes the initialization process for the batch estimator.

2.2.1.2 Estimation State Machine

Figure 2.6 shows the estimation process implemented in the BatchEstimator class. The batch estimator state machine is shown in the lower partition in the figure, while the actions performed by the command running the state machine are shown in the upper partition. The state machine implementation is key to the estimation process in GMAT, so it will be described in some detail in the following paragraphs.

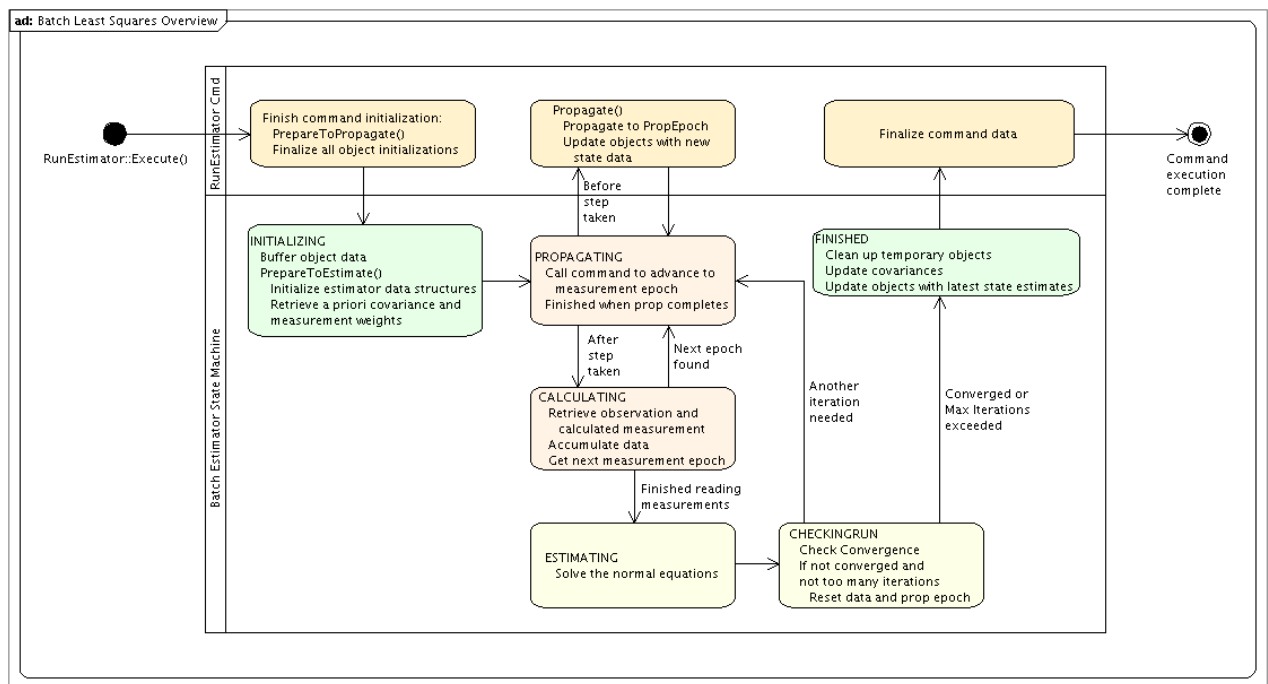

Figure 2.6: Performing Batch Estimation

GMAT’s Solver State Machines GMAT’s solver finite state machines are used to move the solution algorithm through the steps required to apply the algorithm to the objects that are used to solve a user specified problem. Each step of the process is represented by a discrete numerical identifier, referred to as the state of the process. That identifier is used to specify a set of actions that, when performed, prepare the finite state machine to advance from its current state to the next state in the solution process. The state identifiers are defined in a C++ enumeration, the SolverState enumeration in the Gmat namespace.

Each state in the solver state machine performs actions designed to move the elements of GMAT from their entry condition to the condition required to advance to the next state. GMAT advances from one state to the next using the AdvanceState() method on the solver. When AdvanceState() is called, the solver executes a method assigned to the state and reports the results to the solver’s text file. The method call is responsible for running the actions assigned to the state, and then determining the next state and changing the state identifier accordingly based on the results of the actions executed.

The BatchEstimator Finite State Machine The BatchEstimator uses seven states to drive its algorithm. These seven states, shown in the bottom partition of Figure 2.6, work together to estimation a user defined state vector. The list below describes each state of the machine, including the entry and exit conditions along with the internal actions required to move to the exit condition for the state:

INITIALIZING

- **Entry condition** The INITIALIZING state is the state the BatchEstimator takes upon completion of initialization in the Sandbox. Upon completion of an estimation run, the BatchEstimator returns to this state so that a subsequent call can reuse the same estimator.
- **Actions** *Method Name: CompleteInitialization()*
 - Determine if any observations are available; if not, abort estimation If necessary, propagate to estimation epoch Gather the data and fill the batch estimator’s state Initialize the state transition matrix Gather a priori covariances and measurement weights Buffer all estimation objects
- **Exit condition**
 - Change to PROPAGATING state if an observation exists. Change to FINISHED state and post a warning message if none were found².

PROPAGATING

- **Entry condition** An observation was found
- **Actions** *Method Name: GetStepEpoch()*
 - Determine time step for propagation to the observation epoch
 - Feed time step to command for propagation
 - Determine if measurement for the observation has events that require propagation
- **Exit condition 1**
 - Time step = 0
 - No unprocessed propagation events
 - Change state to CALCULATING
- **Exit condition 2**
 - Time step = 0
 - Events that require propagation not yet processed
 - Change state to LOCATING

LOCATING

- **Entry conditions**
 - An event that requires propagation has been found
 - Resources are at a known epoch for the event
- **Actions** *Method Name: ProcessEvent(bufferData)*
 - If bufferData is true, buffer state information
 - Calculate time step required for the event
 - Provide time step to command for propagation
 - Evaluate event to determine if propagation results are within tolerance

²The state machine in the figure shows the nominal path through the process. Anomalous paths, like the absence of observation data mentioned here, are not included in the figure

- Iterate from time step calculation until event converges
- **Exit condition 1**
 - Event has converged
 - No additional events found
 - Reset state information to buffered data
 - Set `bufferData` flag to true
 - Change state to PROPAGATING
- **Exit condition 2**
 - Event has converged
 - Another event found
 - Set `bufferData` flag to false
 - Change state to LOCATING

CALCULATING

- **Entry condition** Propagation and any required event location has been performed
- **Actions** *Method Name: Accumulate()*
 - Retrieve observation and calculated data
 - Accumulate the data
 - Retrieve the epoch of the next observation
- **Exit condition 1**
 - Another observation was found
 - Change state to PROPAGATING
- **Exit condition 2**
 - Final observation was processed
 - Change state to ESTIMATING

ESTIMATING

- **Entry condition** All measurement data has been processed
- **Actions** *Method Name: Estimate()*
 - Solve the normal equations
- **Exit condition**
 - Estimation update generated
 - Change state to CHECKINGRUN

CHECKINGRUN

- **Entry condition** An estimation update was generated
- **Actions** *Method Name: CheckCompletion()*
 - Check for convergence
- **Exit condition 1**
 - Estimation converged within tolerances
 - Change state to FINISHED
- **Exit condition 2**

- Estimation did not converge
- Maximum number of iterations exceeded
- Change state to FINISHED
- **Exit condition 3**
 - Estimation did not converge
 - Maximum number of iterations not exceeded
 - Reset data and prop epoch through call to Reinitialize()
 - Update state with new estimate through call to Update()
 - Reset measurement iterator to point to first measurement
 - Change state to PROPAGATING

FINISHED

- **Entry condition** Estimation work finished
- **Actions** *Method Name: RunComplete()*
 - Update covariances
 - Update objects
 - Clean up data structures
 - Report convergence status
- **Exit condition**
 - Change state to INITIALIZING so estimator is reentrant

2.2.2 BatchEstimator Members

BatchEstimator Attributes The batch estimator does not have any additional attributes visible to the rest of the system. The structures required for accumulation consist of vectors of the processed data required to solve the normal equations. These data structures are algorithm specific, and are defined in the classes derived from the BatchEstimator class.

BatchEstimator Methods

- **virtual bool Initialize():** Prepares the estimator for estimation. The initialize method ensures that all of the top level components needed are present for the estimation process, and performs as much pre-run initialization as possible.
- **virtual Gmat::SolverState AdvanceState():** Executes the state machine actions necessary to move into a new state, and then advances the state to the next value in the finite state machine's process.
- **virtual void CompleteInitialization():** Completes the initialization process, performs any necessary final propagation to move to the estimation epoch, and buffers the data that needs to be reset each time the batch process starts a new iteration.
- **virtual void FindTimestep():** Compares the current state epoch with the next measurement epoch, and computes the time step – in seconds – that the propagator must apply to move from the current epoch to the measurement epoch.
- **virtual void Update():** Applies corrections to the state to incorporate the changes necessary to build a new estimated state.
- **virtual void Reinitialize():** Resets all of the buffered data so that a new iteration can be performed.
- **virtual void RunComplete():** Finalizes all of the data, cleans up memory, and reports the estimation data.

BatchEstimator Abstract Methods The classes derived from the BatchEstimator class implement batch estimators that differ in the details of the estimator mathematics. At a minimum, the derived classes must implement three methods: an Accumulate() method designed to collect the information needed from a pass through the measurement data, and Estimate() method that applies the batch algorithm to calculate state vector updates for the estimation state, and a CheckCompletion() method that tests the state updates and other criteria to determine if the estimation process should terminate. These methods are listed here:

- **virtual bool BuildDataStructures() = 0:** Method called by Initialize() to set up object specific data structures for the classes derived from the BatchEstimator class.
- **virtual void Accumulate() = 0:** Performs data accumulation for the batch algorithm.
- **virtual void Estimate() = 0:** Applies the batch algorithm to generate a new set of corrections to the estimation state vector at the estimation epoch.
- **virtual void CheckCompletion() = 0:** Checks to see if the estimation process should terminate, either because of convergence or for another reason.

2.3 The BatchLeastSquares Class

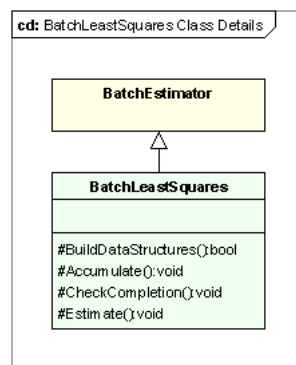

Figure 2.7: The BatchLeastSquares Class

The BatchLeastSquares class, shown in Figure 2.7, captures the mathematics of the accumulation and estimation processes.

2.3.1 Key Processes

The key processes performed by the BatchLeastSquares class are described in the parent class's text. The BatchLeastSquares class does not provide any additional process level elements. It does provide a specific implementation of the batch least squares algorithm, captured in the implementation of the four abstract methods BuildDataStructures(), Accumulate(), Estimate(), and CheckCompletion().

2.3.2 BatchLeastSquares Members

BatchLeastSquares Attributes The BatchLeastSquares estimator does not require any new data members that need description at this level of the design.

BatchLeastSquares Methods

- **virtual bool BuildDataStructures():** Method called by Initialize() to set up the data structures used for accumulation in the BatchLeastSquares estimator.
- **virtual void Accumulate():** Collects the observed less calculated data and derivative information needed to build the normal equations.
- **virtual void Estimate():** Solves the normal equations, generating the corrections that apply to the estimation state vector to construct a new estimate.
- **virtual void CheckCompletion():** Checks the estimate to see if the estimation has converged or if another stopping criterion has been met. If not, the most recent state corrections are applied to the estimation state vector.

2.4 The Simulator Class

GMAT's Simulator class is derived directly from the Solver class, and capitalizes on the state machine infrastructure provided by that class. Simulators inherit these structures and use them to drive the simulation process. Figure 2.8 shows the structure of the Simulator class, described in this section.

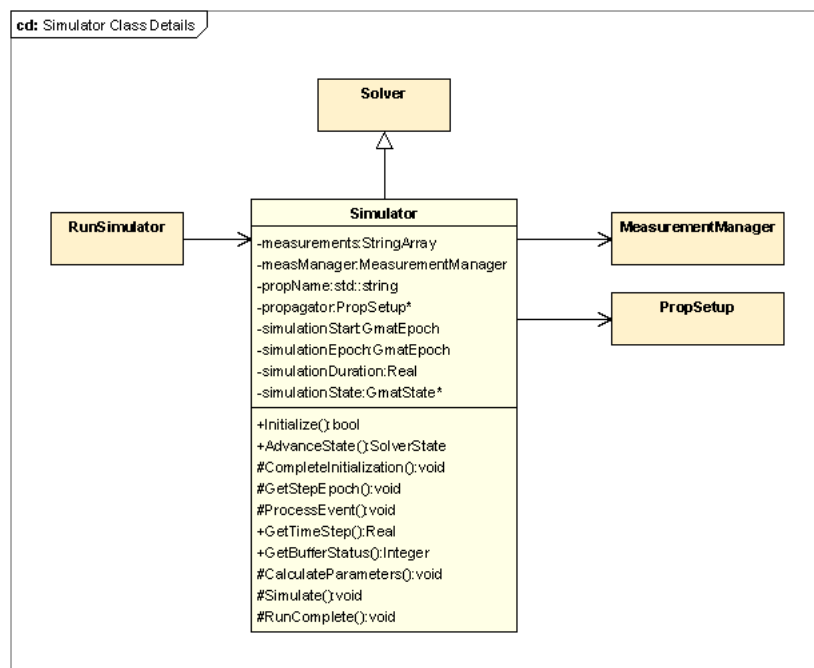

Figure 2.8: The Simulator Class

2.4.1 Key Processes

The Simulator class has two key processes: the Initialize() method, which initializes its management members and prepares its propagation subsystem for initialization, and the AdvanceState() method, which drives the simulation state machine.

2.4.1.1 Simulator Initialization

The initialization process manages the initialization of the MeasurementManager, PropSetup, and the referenced objects associated with these members. The MeasurementManager initialization, described in the MeasurementManager class description, prepares the Measurement objects for use in the simulation. The initialization for the PropSetup performs the pre-initialization steps so that the ODEModel and associated state data can be initialized at the start of the RunSimulator::Execute() call during the Mission Control Sequence run.

2.4.1.2 The Simulation State Machine

The Simulator uses six states to drive its algorithm. These six states, shown in the bottom partition of Figure 2.9, work together to simulate measurement data for a mission.

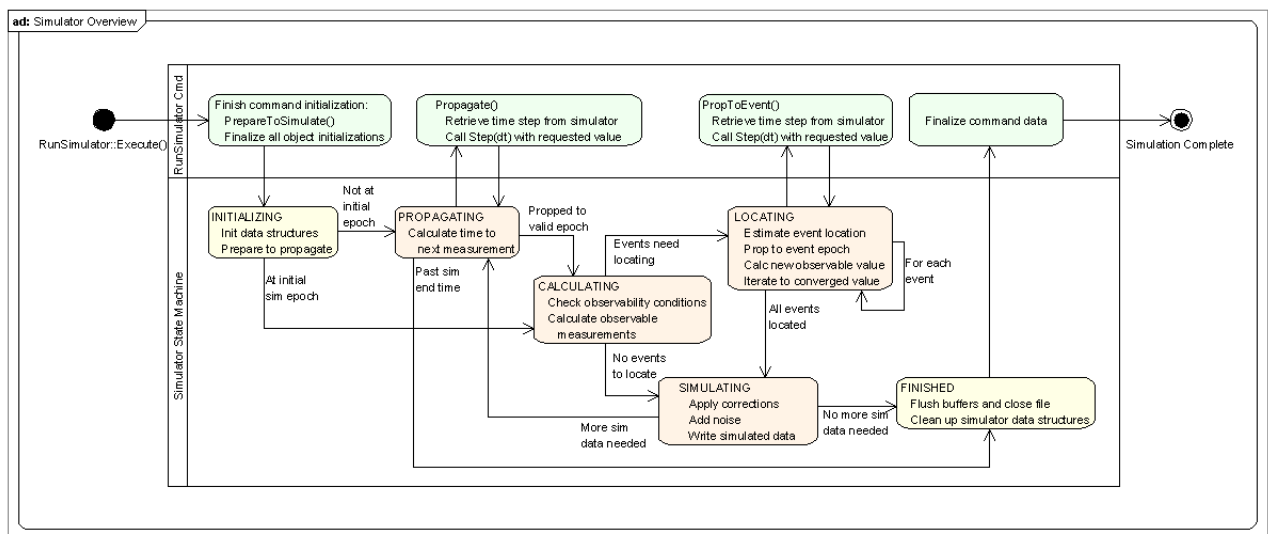

Figure 2.9: The Simulation State Machine

The list below describes each state of the machine, including the entry and exit conditions along with the internal actions required to move to the exit condition for the state:

INITIALIZING

- **Entry condition** The INITIALIZING state is the state the Simulator takes upon completion of initialization in the Sandbox. Upon completion of a simulation run, the Simulator returns to this state so that a subsequent call can reuse the same simulator.
- **Actions** *Method Name: CompleteInitialization()*
 - Gather the data and fill the simulator’s state. Get current epoch from spacecraft participants, make sure all participants have the same epoch. If not, throw an exception.
- **Exit condition 1:**
 - Change to PROPAGATING state if current epoch is not the simulation start epoch
- **Exit condition 2:**
 - Change to CALCULATING state if current epoch is the simulation start epoch

PROPAGATING

- **Entry condition:** A new observation needs to be simulated.
- **Actions** Method Name: `GetStepEpoch()`
 - Determine time step for propagation to the observation epoch
 - Provide time step to command for propagation on request
 - Determine if measurement for the observation has events that require propagation
- **Exit condition 1**
 - Propagation to the desired time has occurred
 - No unprocessed propagation events
 - Change state to `CALCULATING`
- **Exit condition 2**
 - Propagation to the desired time has occurred
 - Current epoch is past simulation end time
 - Change state to `FINISHED`

LOCATING

- **Entry conditions**
 - An event that requires propagation has been found
 - Resources are at a known epoch for the event, called the anchor epoch.
- **Actions** Method Name: `ProcessEvent()`
 - Manage the flag used to handle buffer state information
 - Calculate time step required for the event
 - Provide time step to command for propagation on request
 - Evaluate event to determine if propagation results are within tolerance
 - Iterate from time step calculation until event converges
- **Exit condition 1**
 - Event has converged
 - No additional events found
 - Reset state information to buffered data
 - Change state to `SIMULATING`
- **Exit condition 2**
 - Event has converged
 - Another event found
 - Change state to `LOCATING` and start a new iteration

CALCULATING

- **Entry condition:** Epoch is at a simulation epoch.
- **Actions** Method Name: `CalculateParameters()`
 - Determine observability for measurements at the current epoch
 - Measurement manager gets and stores measurement values for the current epoch
- **Exit condition 1**
 - No measurements are observable

- Change state to PROPAGATING
- **Exit condition 2**
 - At least one measurement primitive was calculated
 - No propagation is required for corrections
 - Change state to SIMULATING
- **Exit condition 3**
 - At least one measurement primitive was calculated
 - Corrections that require event finding were detected
 - Change state to LOCATING

SIMULATING

- **Entry condition:** All measurements and events at the current epoch have been pre-processed
- **Actions** *Method Name: Simulate()*
 - Apply corrections to all observable measurements
 - Tell measurement manager to write measurement data to the measurement data stream
 - Calculate the time step to the next measurement that needs to be simulated
- **Exit condition 1**
 - Measurement data was written to the data stream
 - Propagation time step remains within the simulation span
 - Change state to PROPAGATING
- **Exit condition 2**
 - Measurement data was written to the data stream
 - Propagation time step remains outside of the simulation span
 - Change state to FINISHED

FINISHED

- **Entry condition:** Simulation work finished
- **Actions** *Method Name: RunComplete()*
 - Clean up data structures
 - Flush and close the measurement data stream
- **Exit condition**
 - Change state to INITIALIZING so simulator is reentrant

2.4.2 Simulator Members

Simulator Attributes

- **StringArray measurements:** Names of the measurement models used in this simulator. This array of names is passed to the MeasurementManager for processing.
- **MeasurementManager measManager:** The MeasurementManager for the simulator
- **std::string propName:** Name of the configured propagator used to evolve objects during the simulation process.
- **PropSetup *propagator:** The propagator configured for the simulation.

- **GmatEpoch simulationStart**: The start epoch for the simulation.
- **GmatEpoch simulationEpoch**: The current epoch of the simulation.
- **Real simulationDuration**: The length of the simulation, in seconds.
- **GmatState *simulationState**: The state vector that is propagated.

Simulator Methods

- **bool Initialize()**: Validates reference objects and sets up all available interconnections in the simulator.
- **Solver::SolverState AdvanceState()**: Evaluates the status of the finite state machine and implements transitions between states.
- **virtual void CompleteInitialization()**: Performs the final initialization steps needed before executing the simulation. This method is called when the finite state machine is in the INITIALIZING state, and completes the actions required to transition to the next state.
- **virtual void GetStepEpoch()**: Determines the time step to the next epoch for access by the RunSimulator command. This method is called when the finite state machine is in the PROPAGATING state.
- **virtual void ProcessEvent()**: Determines the next time step needed to manage event finding. This method is called when the finite state machine is in the LOCATING state. It may be called repeatedly as the event finding algorithm seeks the location of one or more events.
- **Real GetTimeStep()**: Retrieves the most recently computed time step for use in propagation. This public method is called by the RunSimulator command to determine the desired propagation step size.
- **Integer GetBufferingStatus()**: Returns -1 if objects need to be restored from the buffered objects in the RunSimulator command, 0 if the buffers are not to be accessed, and +1 if the simulation objects need to be buffered. This public method is called by the RunSimulator command to determine when buffer actions are needed.
- **virtual void CalculateParameters()**: Calculates measurement data in the measurement primitives. This method is called when the finite state machine is in the CALCULATING state.
- **virtual void Simulate()**: Calculates the fully corrected measurement values that are reported to the measurement data stream, and writes those data to the stream. The measurement data stream can be either a file, a database, or a live data stream. (The initial estimation builds of GMAT support the file option.)
- **virtual void RunComplete()**: Cleans up the data structures used during the simulation, flushed the data buffers associated with the measurement data stream, and closes the stream.

Chapter 3

Commands used in Estimation and Simulation

Stephen P. Hughes
NASA/Goddard Space Flight Center

Darrel J. Conway
Thinking Systems, Inc.

Matthew P. Wilkins
Schafer Corporation

GMAT's Solver subsystem uses a finite state machine model to drive the algorithms implanted in the solvers. Each Solver object implements its own state machine, and pairs that state machine with a command or set of commands that manipulates GMAT's objects to provide data required for the algorithm. The interaction between the solver and the command subsystem necessitates knowledge on the command side about the state information in the finite state machine. In essence, the Solver finite state machine drives both the solver algorithm and a paired state machine implemented in the corresponding command. The state and state transitions of the solution process is always controlled in the Solver object. Object manipulations are performed in GMAT's Mission Control Sequence – and in particular, in the Solver Control Sequence that uses the Solver object.

Each type of Solver is matched to command. The targeters, like the differential corrector, are paired with the Target/EndTarget commands, and use the Vary and Achieve commands for additional communications needed by the targeting algorithms. The optimizers are paired with GMAT's Optimize/EndOptimize commands, and use the Vary, Minimize, and NonlinearConstraint commands for communications.

There are four commands designed to pair with the estimation solvers: RunEstimator, RunSimulator, and (in the future) an Estimate/EndEstimate subsequence pair and a Simulate/EndSimulate subsequence pair. This document describes the state machine activities for the first two commands. The subsequence based command pairs are not part of the first release of GMAT's estimation capabilities, and will be designed (along with any communications related commands) at a later date.

3.1 Command Usage in GMAT

Missions in GMAT are always executed by executing commands in a Mission Control Sequence. The Mission Control Sequence is a linked list of command objects. It is executed inside of one of GMAT's Sandboxes starting with the first node in the list, and progressing until the end of the list is executed. The Sandbox

drives this process when GMAT's Moderator calls the Sandbox's Execute() method. The Sandbox tracks the executing command using a current command pointer, initially set to the first command in the list.

When the mission is run, the Sandbox checks for user interrupts, and then calls the Execute() method on the current command pointer, executing that command. Upon return from this call, the Sandbox updates the current command pointer by calling the command's GetNext() method. The pointer returned from this call is then checked; if it is NULL, the Mission Control Sequence has run to completion. If the returned pointer is not NULL, it points to the next command that needs to be executed, and the process repeats by checking for interrupts and then calling the Execute() method on the command pointed to by the current command pointer. Thus overall control of the process running in GMAT's Sandbox is managed by the commands in the Mission Control Sequence.

Some of the commands in the Mission Control Sequence manage their pointers to the next command in a reentrant fashion. All of the commands that manage subsequences – GMAT's “branch commands” – work this way, as do the commands like Propagate that might take a long time to execute. The call to GetNext() for these commands can return a pointer back to the command itself, rather than the next command in the list. This self reference in the list transversal call (i.e. the call to “GetNext()”) lets GMAT perform other processing during execution of time consuming commands.

3.2 Estimation Command Overview

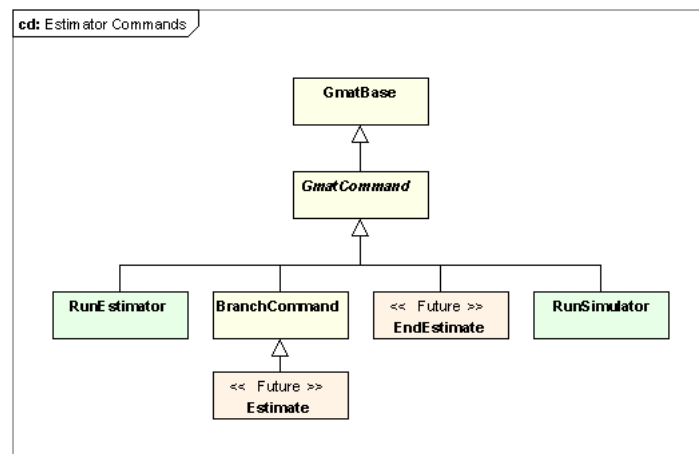

Figure 3.1: Commands Used in Estimation

The three command sets used for estimation – RunEstimator, RunSimulator, Estimate/EndEstimate, and Simulate/EndSimulate, shown in Figure 3.1 – all follow a similar methodology at the level of command execution. The commands interact with the estimator and simulator components to run the solver's finite state machine. Each solver implements a state machine tailored to the needs of the implemented algorithm.

At the highest level, the state machine executes at prompting from the command, which in turn was prompted by a call from the Sandbox containing the Mission Control Sequence, as is shown in Figure 3.2. The estimation command is part of the Mission Control Sequence assigned to a Sandbox in GMAT. When GMAT runs the Mission Control Sequence, it checks for user interrupts, and then calls the Execute method in the current command in the Mission Control Sequence. The figure shows the high level flow that occurs for this process when the current command pointer is an estimation command, including the interactions between the command and the estimator.

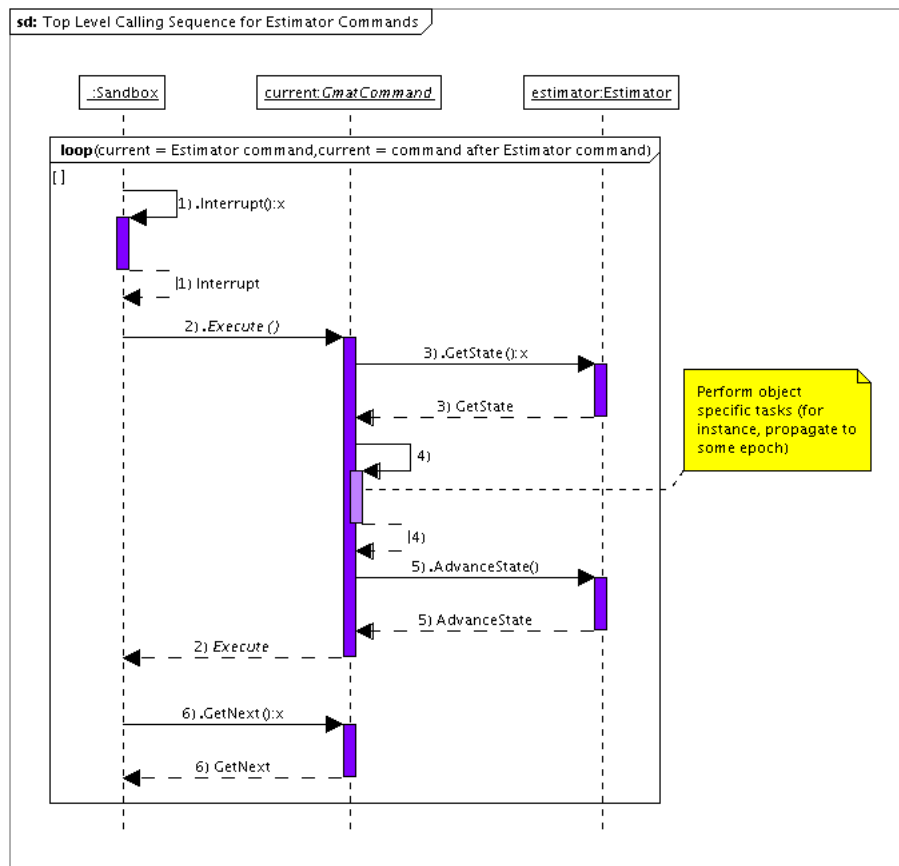

Figure 3.2: Top Level View of State Machine Execution

Each time the estimator command receives a call from the Sandbox to execute (made via the Execute() method), it queries the estimator for the current state, performs any requisite command actions based on that state, and then calls AdvanceState() on the solver so that the solver can perform the next action dictated by the state machine. Upon return from the call to AdvanceState(), the command returns control to the Sandbox, which checks for user interrupts, and then calls the command's GetNext() method to determine the next command that needs to be executed. The estimation command returns its pointer from this call as long as the solver's state machine is running. The Execute() method is called on the command, which lets the estimation command process the next state in the state machine. This sequence repeats until the estimation state machine runs the actions required by the FINISHED state, completing the estimation process. Once the process has completed, a subsequent call to the command's Execute() method returns a reference to the next command in the Sandbox's Mission Control Sequence.

This general framework for estimation command execution in GMAT follows the basic execution framework for all GMAT commands: the Sandbox checks for interrupts, then executes the command, then retrieves the pointer to the next command to execute, and continues this process until the Mission Control Sequence is finished running.

This overview is intended to provide a framework for understanding the details of how the Estimation commands work in GMAT. The following sections describe the estimation commands using the Batch Least Squares estimator to show the state machine elements of the design. The state machine itself is described in

the batch estimator section of this document. The interactions required on the command side for the batch and sequential process are identical; from the point of view of the command, the process is to take an action, call `AdvanceState()` on the estimator, and repeat until the estimator reports that the process is complete. We'll begin by examining the `RunEstimator` command.

3.3 The `RunEstimator` Command

The `RunEstimator` command drives the estimation process when the evolution of the participants can be modeled through propagation from one epoch to the next. `RunEstimator` is a propagation-enabled command, meaning that it includes methods and data structures needed to perform propagation. It supplies methods for performing actions in estimator state machines that support the following states:

- `INITIALIZING`
- `PROPAGATING`
- `LOCATING`
- `CALCULATING`
- `ESTIMATING`
- `CHECKINGRUN`
- `FINISHED`

The `RunEstimator` command provides methods that are called when the estimator's state machine is in one of these states and the `Execute()` command is called. (The command's initialization is performed prior to the state machine call that detects the `INITIALIZING` state, so there is no need for a machine command function for that call.) The command methods that perform actions based on the state of the estimator's state machine are listed here, and described in the command method description below.

- **`INITIALIZING`**: Calls the `PropagateToStart()` method
- **`PROPAGATING`**: Calls to the `Propagate()` method
- **`LOCATING`**: Calls the `PropToEvent()` method
- **`CALCULATING`**: Calls the `Calculate()` method
- **`ESTIMATING`**: Calls the `Estimate()` method
- **`CHECKINGRUN`**: Calls the `CheckConvergence()` method
- **`FINISHED`**: Calls the `Finalize()` method

Different estimators can use different states in their state machines, and are likely to use the states in a different order based on the estimation algorithm. For example, the batch least squares estimator does not use the `ESTIMATING` state until after all of the tracking data has been processed, while the sequential filters like the extended Kalman filter will estimate – that is, advance through the `ESTIMATING` state – as the data is processed.

Figure 3.3 shows the finite state machine for the batch least squares estimator (the lower portion of the sequence partition) and the `RunEstimator` command. The core interaction supplied by the command during execution of the state machine for this example is the propagation of the participants in the estimation process. The batch estimator performs the other steps of the estimation process without need for direct interaction with the command.

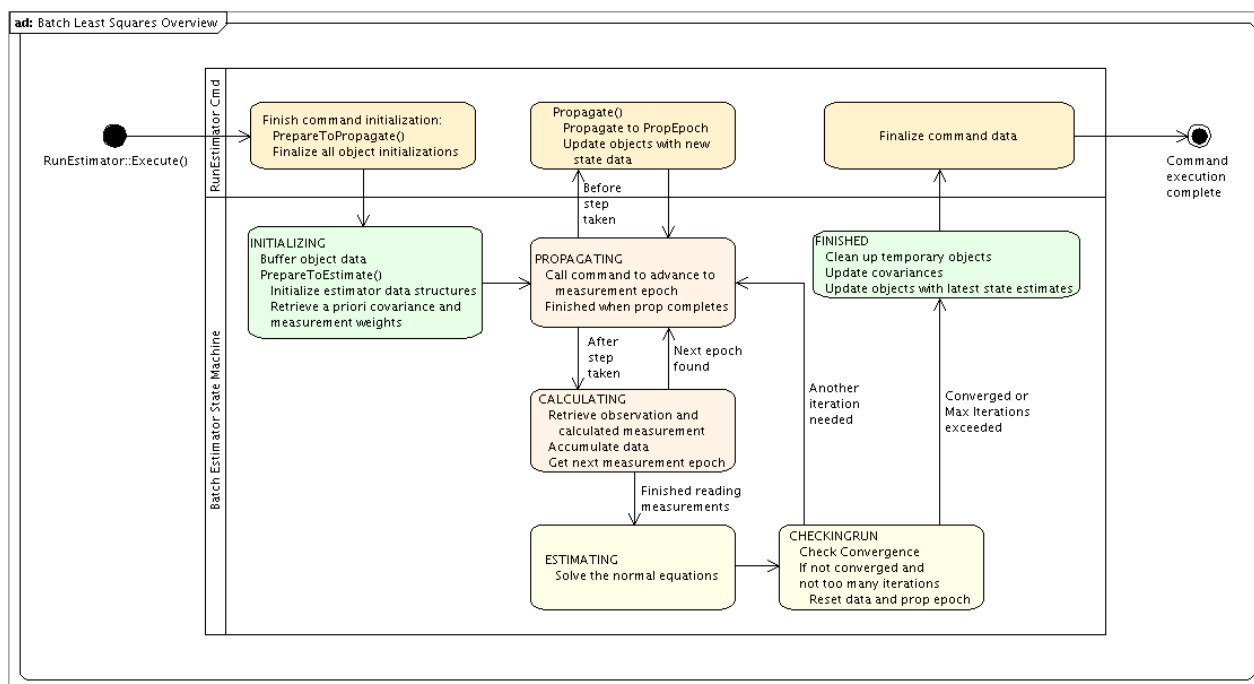

Figure 3.3: Interactions Between the RunEstimator Command and the Batch Least Squares Estimator

Three of the states specified here require propagation from the command. The `INITIALIZING` state requires that the command perform propagation from the current state epoch to the estimation epoch specified on the estimator. GMAT's objects are advanced from their current epoch to the next measurement epoch through calls to the `Propagate()` method, made when the finite state machine is in the `PROPAGATING` state. Finally, event location to perform tasks like light-time corrections requires propagation. These tasks are performed while the state machine is in the `LOCATING` state.

For each of these propagation steps, the `RunEstimator` command needs to know the size of the time step required to change from the current epoch to the desired epoch. This information is retrieved from the estimator using the `FindTimeStep()` method. The returned time step is then used to step the participants using a `PropSetup` reference in the command. That reference, set during command initialization, points to the propagator owned by the estimator. A future enhancement may allow the replacement of the estimator's propagator with a event-specific propagator tailored to the participants in the event calculation for propagation triggered from the `LOCATING` state.

The details of the state machine execution are described in the sections describing each specific estimator. The description provided here is intended to specify the command actions required in the estimation process.

3.3.1 RunEstimator Members

The `RunEstimator` command contains the following data members and methods.

RunEstimator Attributes

- `std::string estimatorName`: The name of the Estimator that the command uses.
- `Estimator *estimator`: A pointer to the Estimator.

- **PropSetup *propagator**: A pointer to the Propagator owned by the Estimator.

RunEstimator Methods

- **virtual bool Initialize()**: Sets internal references and interconnections, and prepares the estimator for use.
- **virtual bool Execute()**: Accesses the state from the finite state machine, performs any required command side actions, and then calls `AdvanceState()` on the estimator to move the finite state machine to its next state.
- **virtual void PropagateToStart()**: Queries the estimator for the time step required to propagate to the estimation epoch, and then performs that propagation.
- **virtual void Propagate()**: Queries the estimator for the next required time step, and then performs the required propagation.
- **virtual void PropToEvent(bool restoreFromBuffer)**: Queries the estimator for the time step estimated to find an event, and then performs the required propagation. This method buffers the initial state data if `restoreFromBuffer` is false, and resets to that buffered data if `restoreFromBuffer` is true. A call to restore when the buffer has not been set results in an exception.
- **virtual void Calculate()**: Performs command side actions when the estimator is in the CALCULATING state. This method is used to report intermediate data if the estimator text file is running in verbose mode.
- **virtual void Estimate()**: Performs command side actions when the estimator is in the ESTIMATING state. This method is used to report intermediate data if the estimator text file is running in verbose mode.
- **virtual void CheckConvergence()**: Performs command side actions when the estimator is in the CHECKINGRUN state. This method is used to report the status of the estimation process.
- **virtual void Finalize()**: Finalizes the command so that it can be reexecuted on a subsequent call. This method is also used to report the final estimated state and the status of the convergence criteria.

3.4 The RunSimulator Command

The `RunSimulator` command is a propagation-enabled command that manages the processes required to run and respond to the finite state machine defined in `Simulator` objects. It supplies methods for performing actions in these state machines that when the finite state takes one of the following values:

- INITIALIZING
- PROPAGATING
- LOCATING
- CALCULATING
- SIMULATING
- FINISHED

The RunSimulator command provides methods that are called when the simulator's state machine is in one of these states and the Execute() command is called. The command methods that perform actions based on the state of the simulator's state machine are listed here, and described in the command method description below.

- **INITIALIZING:** Calls the PrepareToSimulate() method
- **PROPAGATING:** Calls to the Propagate() method
- **LOCATING:** Calls the PropToEvent() method
- **CALCULATING:** Calls the Calculate() method
- **SIMULATING:** Calls the Simulate() method
- **FINISHED:** Calls the Finalize() method

Figure 3.4 shows the finite state machine for the simulator in the lower portion of the sequence partition, and the non-trivial processes executed in the RunSimulator command. The core interaction supplied by the command during execution of the simulator state machine is the propagation of the participants in the simulation process. The simulator performs the other steps of the process without need for direct interaction with the command.

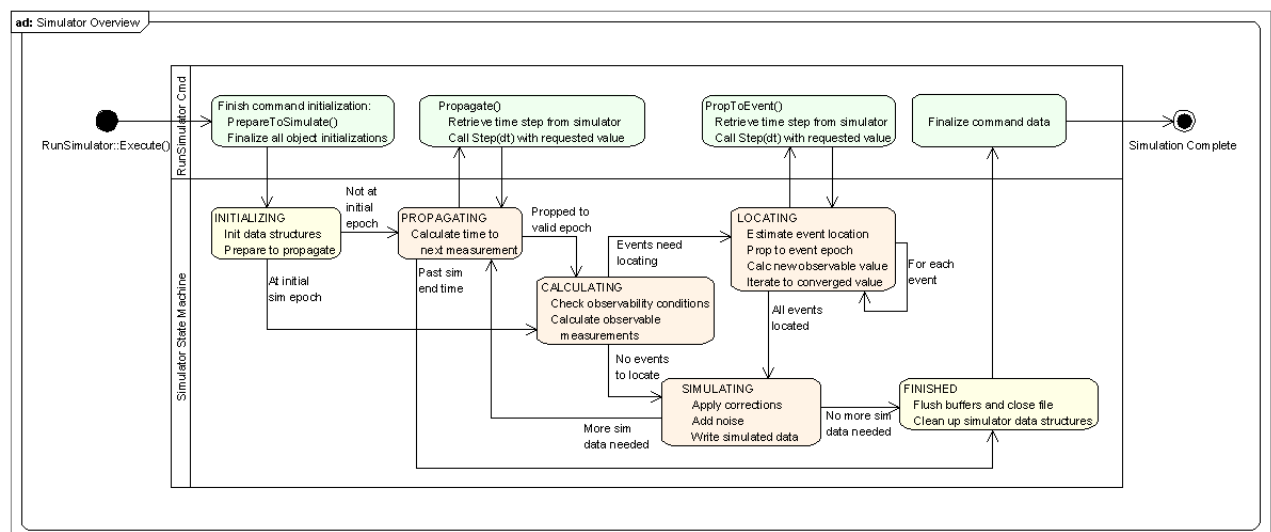

Figure 3.4: The Simulation State Machine

The RunSimulator command defines the interface between the Mission Control Sequence running in a Sandbox and a Simulator object. The RunSimulator command manages all of the propagation performed in support of the simulation, simplifying the interrupt processing during the simulation.

In GMAT, the simulator object owns the propagator and the measurement manager. The command retrieves the propagator pointer from the simulator for use during command execution. The simulator also provides the information about the duration of any needed propagation to the command. The RunSimulator command manages a buffer of objects that are propagated in support of the simulation, and uses this buffer to restore object data when performing calculations that would otherwise corrupt the time dependent states of those objects. As an example, this object buffer is used during light time iterations so that the object states at the anchor time for a measurement can be restored after iteration has converged on the light time correction.

3.4.1 Key Processes

The RunSimulator command has two key processes, captured in the Initialize() and Execute() methods.

3.4.1.1 Initialization

The RunSimulator::Initialize() method performs the usual reference object location and setting tasks performed by all commands. For the RunSimulator command, this process involves finding the associated Simulator and cloning it for local use. The Clone() process for a Simulator object includes a call that creates a clone of the propagator (a PropSetup object) used in the simulator. The RunSimulator command retrieves a pointer to that clone for use when propagating elements of the simulation. The command does not make an additional clone based on the simulator's propagator; it works directly with the propagator owned by the cloned simulator.

3.4.1.2 Execution

The RunSimulator::Execute() method determines the current state of the simulator's finite state machine, performs command side actions in response to that state, and then calls the simulator's AdvanceState() method so that the simulator can respond to the results of these actions.

Two specific states in the simulator use this interaction to trigger propagation: the PROPAGATING state is used to advance GMAT from one simulation epoch to another, and the LOCATING state is used to perform tuning of a simulated measurement through corrections that require propagation like light time iteration. In both of these cases, the simulator is responsible for determining the size of the propagation steps that are necessary for the underlying process. The RunSimulator command manages the actual evolution of the system based on the time step data retrieved from the simulator.

The propagation required in the LOCATING state requires buffering of information so that the objects in the simulation can be restored to their settings at the anchor epoch for the measurement. The RunSimulator command determines when states should be buffered and reset through calls to the simulator.

3.4.2 Class Design

Figure 3.5 shows the top level internal structure of the RunSimulator command. RunSimulator is derived directly from the GMatCommand base class. It references a Simulator object and, through that object, a PropSetup which provides the propagator infrastructure used by the command.

3.4.3 RunSimulator Members

RunSimulator Attributes

- **Gmat::SolverState simState**: Tracks the state coming from the simulator's finite state machine so that appropriate actions can be triggered.
- **std::string propName**: Name of the PropSetup used to evolve the objects involved in the simulation.
- **PropSetup *prop**: A pointer to the simulator's copy of the configured PropSetup.
- **std::string simName**: The name of the simulator that implements the finite state machine.
- **Simulator *sim**: A pointer to the simulator clone that is used with this command.
- **std::vector<SpacePoint*> buffer**: A local data buffer used to store copies of the simulation participants so that they can be restored later.

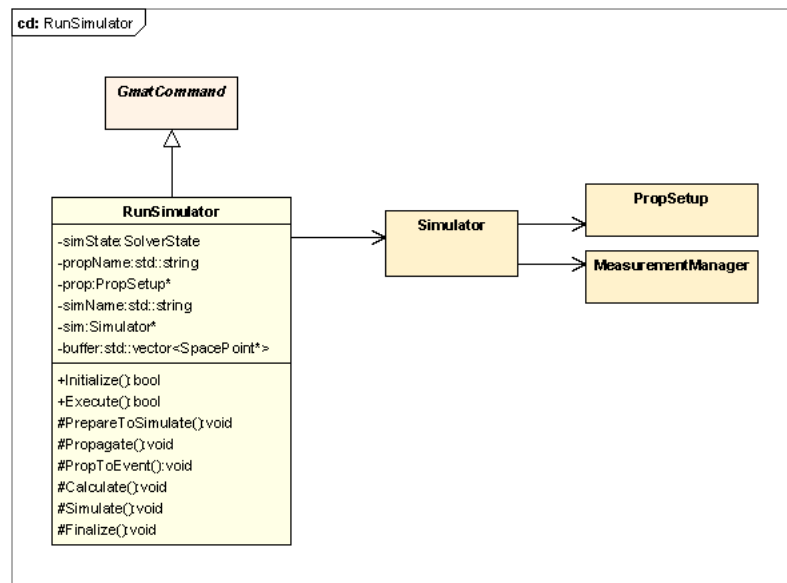

Figure 3.5: The RunSimulator Class

RunSimulator Methods

- **virtual bool Initialize():** The method used to wire together all of components of the simulation that are available prior to execution of the Mission Control Sequence.
- **virtual bool Execute():** The Mission Control Sequence entry point to the simulation. This method makes calls to the AdvanceState() method on the simulator to drive the finite state machine.
- **void PrepareToSimulate():** Method used to complete command initialization prior to execution of the finite state machine. This method is triggered when the finite state machine is in the INITIAL-IZING state, prior to actual calls to the state machine. The PropSetup completes initialization of its ODEModel and propagation state data during this call.
- **void Propagate():** Propagates the components of the simulation when the finite state machine is in the PROPAGATING state. This method queries the simulator for the desired time step (specified in seconds), and propagates by that duration to the next simulation epoch. If the simulator specifies a zero time step, the command propagates by the natural time step of the propagator in the PropSetup.
- **void PropToEvent():** Propagates the components of the simulation when the finite state machine is in the LOCATING state. This method buffers the state data if necessary, queries the simulator for the desired time step (specified in seconds), and propagates by that duration to the next simulation epoch. If the simulator specifies a zero time step, the command throws an exception and stops the simulation.
- **void Calculate():** Method called when the finite state machine is in the CALCULATING state. This method is used to report status to the simulator text file.
- **void Simulate():** Method called when the finite state machine is in the SIMULATING state. This method is used to report status to the simulator text file.
- **void Finalize():** Cleans up the data structures used during the simulation, including the objects in the object buffer. This method is triggered when the simulator is in the FINISHED state.

Draft for Release 2011a Beta

Chapter 4

Events and Event Location

Darrel J. Conway
Thinking Systems, Inc.

4.1 Introduction

GMAT provides a capability to determine precise epochs for important physical events along a modeled trajectory. Examples of these events are shadow entry and exit, station rise and set, and other time-based quantities like the light time offset transmission and turn around of a tracking signal. Some of these quantities can be further processed to determine eclipse and station contact durations and similar time span quantities associated with detected event pairs. GMAT's mathematical specification[[MathSpec](#)] defines the event detection algorithm in some detail. This chapter describes the software components that implement that algorithm.

4.2 Components that Control Event Processing

Event location in GMAT is controlled through interactions between five types of objects, and their interactions with the objects comprising the simulation designed by the user. The five objects that work together to perform event location for these modelled objects are a propagation enabled command, a propagator contained in a PropSetup object, one or more Event objects, an EventManager, and a RootLocator. These components play the following roles in the event location process:

- **Propagation Enabled Command:** Provides the mission control sequence interfaces for event location. Event locating is performed during execution of a propagation enabled command. (Event evaluation can also be performed through parameter calculations tailored to report data from specific event objects.)
- **PropSetup:** Provides the propagator used to search for the event location. Any GMAT propagator can be used in this context, including (once coded) ephemeris interpolators.
- **Events:** One or more objects responsible for providing calculations used to evaluate a measure of the desired event. The Event objects all provide an Evaluate method that generates one or more Real values. The values calculated in the Evaluate method are function values that evaluate to 0.0 at the epoch of the event, and that pass smoothly through zero as the data used in the evaluation are propagated through the time interval containing the event.
- **Event Manager:** Acts as a mediator to control data interactions between the Event objects and the other components involved in the location process.

- **Root Locator:** Manages the details of the propagation or interpolation needed to precisely locate the events on the mission timeline.

Event location is used in two distinct settings in GMAT. During a typical mission run, users can script specific events that they would like to track for the purposes of reporting and analysis. GMAT's propagation subsystem provides a mechanism to watch for these events as the mission is run, and locates the resulting events as they are encountered, tracking their location for the user. Event location is also performed in the estimation subsystem, so that measurement corrections that require propagation to manage detailed precision calculation can find and propagate to the epochs for those events during the correction process.

GMAT manages two types of events: discrete events that occur at a single instant of time, and interval events that occur over a span of time. In both cases, the epochs associated with the events are detected through zero crossings of a function. Interval events track the start and end time for the event, and can be used to calculate the interval of time over which the event occurred. For interval events, the event is deemed to be occurring while the event function provides a positive value. Interval events that provide more than one Real value on event evaluation track the event span through the first event function evaluated; in other words, the first function value should be positive – and all event criteria met – while the interval event is happening.

This chapter presents the design for the former application. Event processing during estimation follows the same process as generic event location, with a few additional steps required to synchronize the measurement models with the event location data. The estimation based event location refinements are presented in Chapter 6.

4.3 The Event Location Process

Figure 4.1 shows the details of the event location process. Events that need to be located are registered with the propagation enabled command in the `PrepareToPropagate()` method prior to execution of the command. At this point the `EventManager` evaluates each active `Event` and stores the event data so that the pre-propagation event state is known. The propagation enabled command then takes a propagation step. After the step has been taken, the `EventManager` again evaluates each event, and uses the results of that evaluation to determine if the event has a zero crossing or extremum in the propagation interval. If no such trigger has occurred, the command continues processing – either by taking additional propagation steps, or by exiting, returning control to the `Sandbox` so that the mission control sequence can continue executing.

If a zero crossing or extremum is detected in the propagation step, the event location code needs to perform additional processing. This additional processing is controlled by a `RootLocator` object set during the command's initialization. If necessary, the `RootLocator` is passed a pointer to the `PropSetup` associated with the located event¹. Control is then handed to the `RootLocator` responsible for locating the epoch of the detected crossing or extremum through a call to the `EventManager`'s `FindRoot()` method.

The `EventManager` buffers the propagated state of the object or objects participating in the event, and then calls the `FindRoot()` method on a `RootLocator` configured to work with the event that triggered the search. The `RootLocator` performs a series of propagations to epochs inside of the time span covered by the step that triggered the call to `FindRoot()`. These propagations search for any zero crossings in the propagation interval, and complete when the zero crossings in the interval have been located or when a maximum number of search steps have been performed. Once this has happened, control is passed to the `EventManager`, which saves the detected event data, and then returns control to the propagation enabled command.

The event location code uses several classes specialized to the location process. These new classes, along with key methods implemented in them, are described in the following section.

¹Some propagation enabled commands set the `PropSetup` pointer at initialization; for others, the `PropSetup` must be set at this point during execution. The key differentiator for this determination is the relationship of the `PropSetup` to the other activities performed by the command. Commands that only use a single `PropSetup` can set the pointer during initialization, while those that use multiple `PropSetups` must set the pointer at this point in the process.

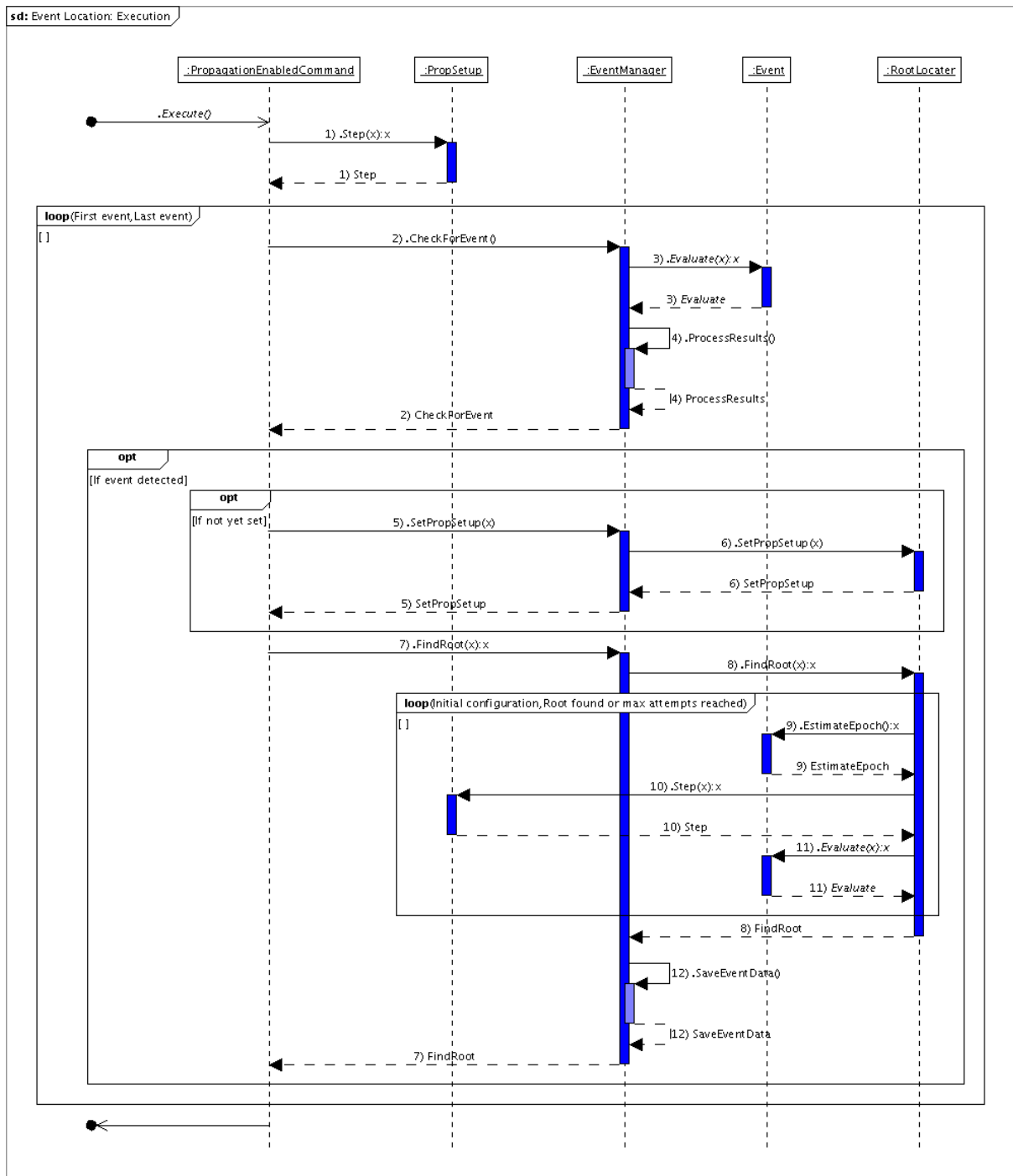

Figure 4.1: The Event Location Process

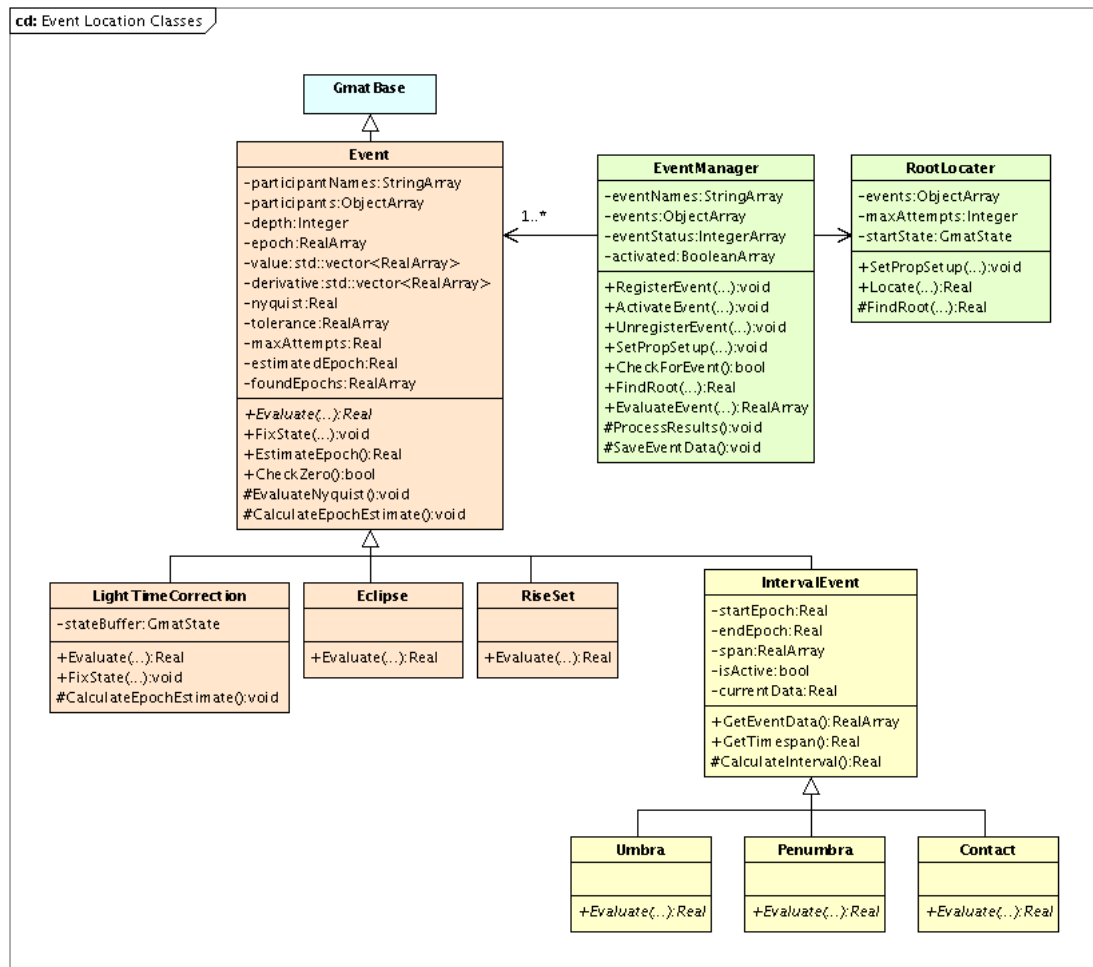

Figure 4.2: Event Location Classes

4.4 Event Location Classes

Figure 4.2 shows the class relationships between events, the event manager, and the root finder. the following paragraphs describe each of these classes in some detail.

4.4.1 Event Classes

Three specific events are shown in the Figure 4.2: the RiseSet event, the Eclipse event, and the Light-TimeCorrection event. In addition, the IntervalEvent class and three specific interval events are shown. In general, event classes are implemented by deriving a class from the Event or IntervalEvent base class, implementing the Evaluate() method to supply event function and derivative data, and if needed, implementing the FixState() method to preserve state data at a specific epoch. IntervalEvent classes implement additional code used to track the span of the event as well, as is described below.

4.4.1.1 The Event Base Class

All events – discrete or interval – are derived from the Event base class. The Event class provides the interfaces used by the EventManager and RootFinder during the event evaluation process.

Event Attributes Each GMAT Event manages its list of objects participating in the event calculation, a ring buffer of the event function values and derivatives, and data identifying the critical frequency (i.e. the Nyquist frequency) specific to the event. These data are stored in the following data members of the Event class.

- **StringArray participantNames:** Names of the objects that are needed to calculate the event function and derivative information. These names correspond to objects in the currently running model.
- **ObjectArray participants:** Pointers to the objects that participate in the Event's calculations.
- **Integer depth:** The depth of the ring buffer that tracks the event function values and derivatives.
- **RealArray epoch:** Epoch data for the ring buffer.
- **std::vector<RealArray> value:** Event function vectors for the ring buffer.
- **std::vector<RealArray> derivative:** Event function derivatives for the ring buffer.
- **Real nyquist:** The critical frequency for the event. This parameter is set to the largest Nyquist frequency in the event; propagation should be performed with step sizes of $1/\text{nyquist}$ or smaller in order to catch all of the events in a propagation span.
- **Real tolerance:** Numerical tolerance needed for convergence; the event function should evaluate to a magnitude less than this value for located events.
- **Real maxAttempts:** The maximum number of root finding attempts allowed for this event.
- **Real estimatedEpoch:** The estimated epoch for an event, estimated using the current ring buffer data through a call to EstimateEpoch().
- **RealArray foundEpochs:** The array of event location epochs that have been found.

Event Methods The Event class inherits code functionality from GmatBase, and overrides methods as needed to provide Event specific functionality. The Initialize() method, in particular, is overridden but not listed here since all GmatBase subclasses implement that method when needed.

- **Real Evaluate(Integer status) = 0:** Derived classes implement this method to evaluate the event function and derivative function, filling the resulting data into the epoch, value, and derivative data structures.
- **void FixState(GmatBase* obj, bool LockState):** Mechanism used to preserve the state data for a specified object – usually a participant in the event – for later use in event evaluation. This method is called when event evaluation requires data at different epochs, so that the data for one object can be preserved prior to propagation, and then accessed at a post-propagation epoch.
- **Real EstimateEpoch():** Provides an estimated a.1 ModJulian epoch for the event. The estimated epoch is calculated in the CalculateEpochEstimate() method.
- **bool CheckZero():** Tests to see if the current event function evaluates to an event location, within the specified tolerance.

- **void EvaluateNyquist():** Method called during initialization to determine the Nyquist frequency for the event. The `Event::Initialize()` method calls this protected method. Derived classes should override this method with their own version of the method if the default Nyquist frequency, 1.0e-99 Hz – producing basically an unbounded maximum propagation step size – is not correct.
- **void CalculateEpochEstimate():** Estimates the epoch of the event based on the event’s internal data. The default implementation uses the data in the ring buffers to interpolate the event epoch. This method requires that the ring buffer data brackets one or more zero crossings or extrema; events that do not bracket must override this method.

4.4.1.2 Sample Event Subclass: The LightTimeCorrection Class

The classes derived from the `Event` class all follow a similar implementation pattern; rather than repeat that pattern in this text, a representative example of a discrete event is presented here. The `LightTimeCorrection` class is the most complex of these classes in the figure, so it was selected for this example.

Light-time correction is a calculation that accounts for the finite light propagation time between two participants when calculating a physical quantity. It is used, for example, when calculating a range measurement to account for the motion of the participants as the ranging signal travels from one to the other. Since the `LightTimeCorrection` event needs to preserve state data at one epoch while the `RootFinder` propagates to a different epoch, it uses both the `FixState()` method and the `Evaluate()` method. The event function for light time correction is the range difference between the light-time calculated distance (that is, the speed of light times the time interval that the signal is in transit), and the range calculated from the state vectors of the participants, where the participant acting as the receiver has its location evaluated at the time the signal is received, and the transmitter’s location, at the time the signal left the transmitting participant.

LightTimeCorrection Attributes

- **GmatState stateBuffer:** The buffer used to temporarily store state data for one participant in the calculation. For corrections that are tagged with the reception time, the buffer is used to save the state of the receiving participant while the `RootFinder` propagates backwards to the transmission epoch.

LightTimeCorrection Methods

- **Real Evaluate(Integer status):** Calculates the event function and its derivatives, as defined in GMAT’s mathematical specifications[`MathSpec`].
- **void FixState(GmatBase* obj, bool lockState):** Tells the event to buffer the state of the input object. `lockState` is not used in the light time correction, but is supplied to make the method conform to the base class method that is overridden here.
- **void CalculateEpochEstimate():** Estimates the epoch of a light time endpoint using the range calculated from the participant locations. This method uses the `stateBuffer` data as the state of one of the participants for one of the end points, and the current (possibly propagated) state of the other participant as the second endpoint in the calculation.

4.4.1.3 The IntervalEvent Base Class

To be written.

IntervalEvent Attributes

IntervalEvent Methods

4.4.2 The EventManager Class

Event function monitoring and event location are controlled through the EventManager class. Each Sandbox contains an EventManager. The pointer to the local EventManager is passed to each command as the Mission Control Sequence is initialized in the Sandbox. Commands use this event manager to register, access, evaluate, and locate events as the sequence executes. The EventManager acts as a mediator between all of the objects in the location process: it tracks the Events and their status, passes PropSetup objects and control to the RootFinder when an event is ready to be located, and passes event function data to any object that needs it.

The sequence diagrams (Figures 4.1 and 6.2) show how the EventManager functions in these roles. The class attributes and methods are described here:

EventManager Attributes The core attributes of the EventManger are the data structures that track the Event objects and their status, along with the RootLocator used to find the precise event location.

- **StringArray eventNames:** String descriptions of the events that are registered with the event manager.
- **ObjectArray events:** The current set of Event objects registered with the EventManager.
- **RootLocator locator:** The root locator that searches for event locations once an event has been detected.
- **IntegerArray eventStatus:** The current status of the event. This event status flag can be set to SEEKING, ZERO_BRACKETED, EXTREMA_BRACKETED or LOCATED for each active event. These values are enumerated in the EventStatus enumeration, a member structure in the EventManager.
- **BooleanArray activated:** Array of flags indicating if the corresponding Event should be checked. Deactivated Events are skipped in the evaluation process.

EventManager Methods

- **void RegisterEvent(Event newEvent):** Adds an event to the EventManager. When an event is added, it is also evaluated, setting the initial function values on the Event. Added events are automatically active until deactivated by a call to ActivateEvent().
- **void ActivateEvent(Event theEvent, bool makeActive):** Sets the activated state for an event. This call turns on or off event calculations for the specified event, based on the setting of the makeActive flag. When an inactive event is made active, its ring buffer is cleared and the Evaluate() method is called, providing the initial event function data. The method is idempotent: activating an active event has no affect, nor does deactivating a deactivated event.
- **void UnregisterEvent(Event theEvent):** Removes an event from the event queue.
- **void SetPropSetup(Estimator::PropSetup* ps):** Sets the PropSetup that will be used for event location.
- **bool CheckForEvent():** Tests to see if and event has occurred or if an extremum has been encountered.
- **Real FindRoot(Integer whichOne):** Tells the EventManager to call the RootFinder to locate the specified event.

- **RealArray EvaluateEvent(Integer whichOne)**: Returns the current event function values for the specified event. This method can be used to retrieve event function data for use in parameters and data subscribers.
- **void ProcessResults()**: Performs processing to determine the event state.
- **void SaveEventData()**: Saves event data so it can be accessed later.

4.4.3 The RootFinder Class

Event location in GMAT requires a search over time for a zero of one or more event function values. The obtained value must fall within a set tolerance of zero; this tolerance is set on each Event object, and defaults to 1.0e-7. It can be overridden in the Event code. The RootFinder class performs the search for the function roots. It works with methods on the Event classes to retrieve an estimate of the epoch of the root, then drives a PropSetup to move the participants that need propagation to the target epoch. Finally, it calls the Event's Evaluate() method to determine the current values of the event function, followed by a check for convergence.

The key RootFinder members are described here:

RootFinder Attributes The RootFinder uses several internal data structures to manage the root finding process. These data structures, described here, are transitory; they are only current during the root finding process, and may be stale if examined outside of that process.

- **ObjectArray *events**: The current set of Events that are used to search for roots.
- **Integer maxAttempts**: Maximum number of attempts allowed to find the root. When maxAttempts is exceeded, the RootFinder posts a message, discards the event location data, and returns. If a root is located, Events that are being examined because an extremum was detected store the root data, reset the counter, and then search for an additional root.
- **GmatState startState**: The state of all participants at the start of the root search. This state is restored to the participants at the end of the root finding process.

RootFinder Methods The root finder uses a propagator set by the EventManager, along with a list of events that may contain roots. The following methods are used in the root location process:

- **void SetPropSetup(Estimator::PropSetup* ps)**: Passes a propagator to the root finder.
- **Real Locate(ObjectArray &whichOnes)**: Public method called by the EventManager to locate all triggered events. The input ObjectArray contains pointers to all of the Events that need evaluated. The RootFinder evaluates these events in the order that they are entered into the array.
- **Real FindRoot(Event *whichOne)**: This method is the core root finding code. It manages all of the propagation and event evaluation needed to find the roots of the event functions.

Chapter 5

Measurement Classes and Measurement Models

Stephen P. Hughes
NASA/Goddard Space Flight Center

Darrel J. Conway
Thinking Systems, Inc.

Matthew P. Wilkins
Schafer Corporation

The Measurement classes define the interfaces used to work with measurement data during the estimation process. These classes provide access to the observation data, typically provided by way of a data file, using a helper object derived from the MeasurementReader base class. The Measurement classes provide methods that calculate the expected value of a specific measurement type, along with the derivative data needed for estimation. These data include calculation of expected measurements, measurement partials, determination of measurement feasibility, and interactions with root finders to determine tracking schedules and light time corrections. A measurement object acts as a participant in the measurement, as the measurement object contains estimated states associated with measurement errors.

The measurement hierarchy consists of a base class and a tiered hierarchy of derived classes as shown in Figure 5.1. The following sections discuss each class in the hierarchy in detail, starting with the Measurement base class.

5.1 The Measurement Class

The Measurement base class contains member data and functions associated with all measurement objects as well as data associated with parameters that are set by the user when configuring the measurement object. Examples of these data include the measurement file name and format, the data types to be processed from the file, and measurement stochastic properties such as biases and time constants.

The Measurement class defines many of the interfaces implemented in the derived classes so that the estimation process can work with measurement objects using base class references and pointers. These interfaces are defined as either overridable or abstract (that is, pure virtual) methods on the Measurement base class. The derived classes implement custom versions of these methods that are specific to the measurement type being implemented. The data members of the Measurement base class are described below, followed by descriptions of the methods provided in the Measurement base class. Finally, we will describe the MeasurementReader helper class before moving to the definitions of the derived classes.

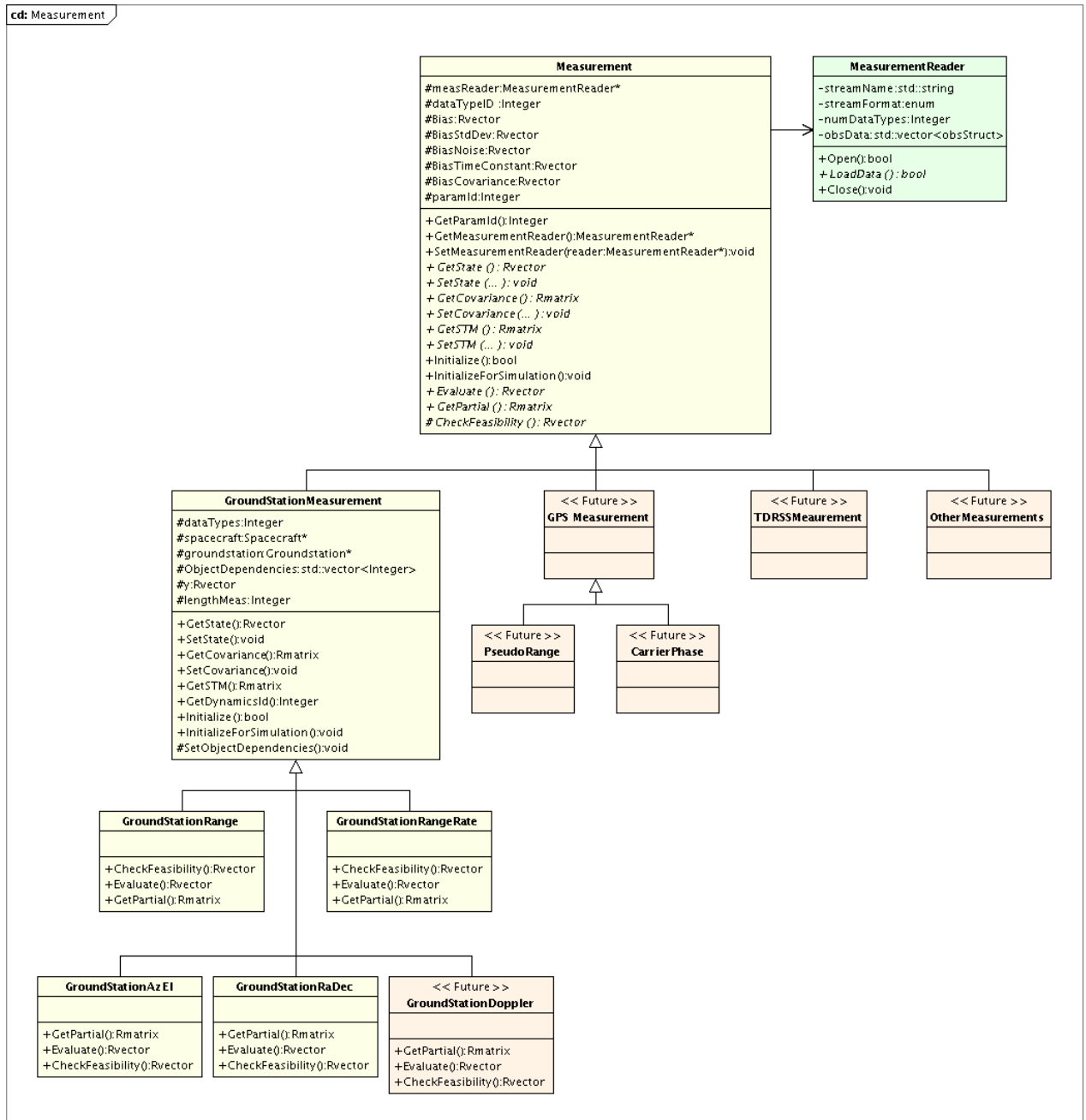

Figure 5.1: The Measurement Class Hierarchy

5.1.1 Measurement Members

Member Attributes The list below describes the data elements provided in the Measurement base class to support the derived classes. These elements are designed to facilitate access to measurement information through calls to a Measurement instance pointer. Some Measurement objects provide multiple data elements. For that reason, some of the data members listed here gain a dimension over what might be expected for single-valued measurements. For example, the ground station RA/Dec measurement type returns two values for each measurement: the right ascension and declination values, so the methods that calculate these values return an Rvector rather than a Real number. Since there are Measurement classes that have this multivalued return requirement, GMAT uses an Rvector for the data, even when the return value is a single number.

The data members of the Measurement are:

- **MeasurementReader *measReader:** The MeasurementReader that supplies the observation data. This pointer can be NULL when simulating data.
- **Integer dataTypeID:** An integer containing the Id for the data type. Although the user may specify several data types on a measurement object, GMAT creates an object for each data type during initialization. Each object has an Id associated with its data type which is specified by dataTypeId.
- **Rvector Bias:** A vector of real numbers containing the measurement biases. These data can be estimation state parameters.
- **Rvector BiasStdDev:** A vector of real numbers containing the standard deviations of the biases. These data can be estimation state parameters.
- **Rvector BiasNoise:** A vector of real numbers containing the noise in the measurement biases. These data can be estimation state parameters.
- **Rvector BiasTimeConstant:** A vector of real numbers containing the time constants for the measurement biases. These data can be estimation state parameters.
- **Rvector BiasCovariance:** A vector of real numbers containing the bias covariances.
- **Integer ParamId:** ID for the type of measurement parameter?
- **Integer numDataTypes:** The number of data types the user specified on the measurement object. During measurement initialization, a new object is created for each data type specified on the measurement object.

Class Methods The Measurement class includes the following methods designed to make access to measurement data as generic as possible by the classes that use Measurement objects. Many of these methods are abstract (pure virtual in C++ terminology): they are defined in this base class, but no implementation is provided in the base class. The abstract classes can be identified by an “= 0” suffix in this list.

- **enum MeasurementFormat:** An enumeration defining the supported measurement formats. Note: This enumeration is not a class member; it is a member of the Gmat namespace.
- **Integer GetParameterId():** A method to determine the integer id for solve-for and consider parameters on the measurement object. This is how the system converts from the string definition provide by the user, say MauiGSRange.Bias,to a numeric Id. <DJC: Not sure of this part.>
- **MeasurementReader *GetMeasurementReader():** Retrieves a pointer to the MeasurementReader.
- **void SetMeasurementReader(MeasurementReader *reader):** Sets the pointer to the MeasurementReader.

- **virtual Rvector& GetState() = 0:** Retrieves the state vector.
- **virtual void SetState(Rvector& newState) = 0:** Sets the state vector to match the provided data.
- **virtual Rmatrix& GetCovariance()= 0:** Retrieves the covariance matrix.
- **virtual void SetCovariance(Rmatrix& newCovariance) = 0:** Sets the covariance matrix data.
- **virtual Rmatrix& GetSTM() = 0:** Retrieves the state transition matrix.
- **virtual void SetSTM(Rmatrix& newSTM) = 0:** Sets the STM matrix data.
- **virtual bool Initialize():** Prepares the Measurement object for use in a Sandbox.
- **virtual void InitializeForSimulation():** Prepares the Measurement object for use during measurement simulation.
- **virtual Rvector& Evaluate() = 0:** Calculates the expected observation value.
- **virtual Rmatrix& GetPartial() = 0:** Retrieves the measurement partial derivative matrix.
- **virtual Rvector& CheckFeasibility() = 0:** Checks to see if a measurement can be made using the current state information.

5.2 GroundstationMeasurement

Measurements that are made at a ground station are modeled using the GroundStationMeasurement class. Data and member functions that are common to all Ground Station measurements are located on the GroundStationMeasurement class, including the participants in the measurement process, Get/Set functions, and common modeling algorithms. Below we discuss in detail all member data and functions.

5.2.1 GroundstationMeasurement Members

GroundStationMeasurement Attributes

- **Integer dataTypes: ???**
- **Spacecraft *spacecraft:** A pointer to the spacecraft that is participating in the measurement. This pointer is set during measurement initialization.
- **Groundstation *groundstation:** A pointer to the ground station that is participating in the measurement. This pointer is set during measurement initialization.
- **std::vector<Integer> ObjectDependencies:** A vector of integers that contains information on how participants on a measurement object map to participants in the overall estimation problem. In general, the participants on a measurement are a subset of the participants for the estimation problem. The ObjectDependencies is used primarily to determine partial derivatives and ensure they are placed in the correct location in the overall partial derivative array. The ESM maintains an array of pointers, called ObjectsVector, to the participant associated with each state chunk in the estimation problem. The ObjectDependencies array is the same length as ObjectsVector. If, for example, element 1 of ObjectDependencies is zero, then the first object in the estimator's participant list is not a participant in the measurement. If element 1 is nonzero, then the integer is associated with the participant Id used internally by the measurement. The ObjectDependencies array is set during initialization when the Measurement Manager makes a call to initialize the measurement.
- **Rvector y:** The vector of calculated measurements.
- **Integer lengthMeas: ???**

GroundStationMeasurement Methods:

- **SetState:** Given a state value and id, this method updates the state on the measurement object.
- **GetState:** Given a state id, this method gets the state from the measurement object.
- **SetCovariance:** Given a covariance matrix and the state id, this method updates the state's covariance on the measurement object.
- **GetCovariance:** Given a state id, this method gets the state's covariance from the measurement object.
- **GetSTM:** Given a state id, this method gets the states' STM.
- **GetDynamicsId:** Given a state Id, this method returns the ODE model ID for use in propagation of the state and it's STM. Not implemented yet for measurement.
- **Initialize:** This method makes a call to the file reader and gets the observations and epochs from the requested data type. If there are multiple data types on the measurement, the measurement object concatenates them into the Obs and Epochs Arrays. These are then extracted by the measurement manager later in the initialization process. For each data type, a new object is created and pointers to the object's participants are set. (Matlab currently only supports one data type per measurement. Not a difficult mod though)
- **InitializeforSimulation:** This method prepares a measurement object for simulation. The process is similar to the Initialize method on GroundStationMeasurement, with the exception the reading and managing observations and epochs is not required.
- **GetDataTypeId:** This method returns the integer Id for the measurement type, given the string name for the measurement.
- **SetObjectDependencies:** This method takes as input an array of pointers to the participants in the estimation state vector. The method steps through each element in the input array and determines if it points to any of the measurement participants. If not, then the element in ObjectDependencies is set to zero. If so, then the element is set to the Id of the participant used internally by the measurement object.

5.3 GroundStationRange

The GroundStationRange class is derived from the GroundStationMeasurement class, and performs modelling range measurements, measurement feasibility, and partial derivatives, and light time iteration.

5.3.1 GroundstationRange Members

GroundStationRange Attributes None. The data members in the GroundStationMeasurement class are sufficient for this class.

GroundStationRange Methods

- **CheckFeasibility:** This method evaluates the feasibility function for the range measurement. If the value of the feasibility function is positive, then the conditions required to perform a measurement are met. If the feasibility function is negative, conditions are not met. Event locators determine the roots of the feasibility function to determine tracking data scheduling.

- **Evaluate:** The evaluate function calculate the computed value of the measurement based on the current state of the participants.
- **GetPartial:** This method returns the requested partial derivative based given a participant Id and the state Id. The participant Ids are contained in the array ObjectDependencies. This method is called by the measurement manager to determine individual partials. The measurement manager assembles the entire partial derivative from the pieces returned by the measurement object.

5.4 The MeasurementManager Class

The measurement manager functions as the interface between the Estimator and the measurement objects defined by the user. The primary jobs of the measurement manager are

- To coordinate measurement data and provide observed and computed values to the estimator
- To maintain the sorted list of observed measurement quantities from all measurement sources.
- To assemble the H matrix for each measurement based on state information and the partials map provided by the measurements.

Chapter 6

Measurement Corrections

Darrel J. Conway
Thinking Systems, Inc.

To be written.

6.1 Introduction

6.2 Additive Corrections

6.3 Event Based Corrections

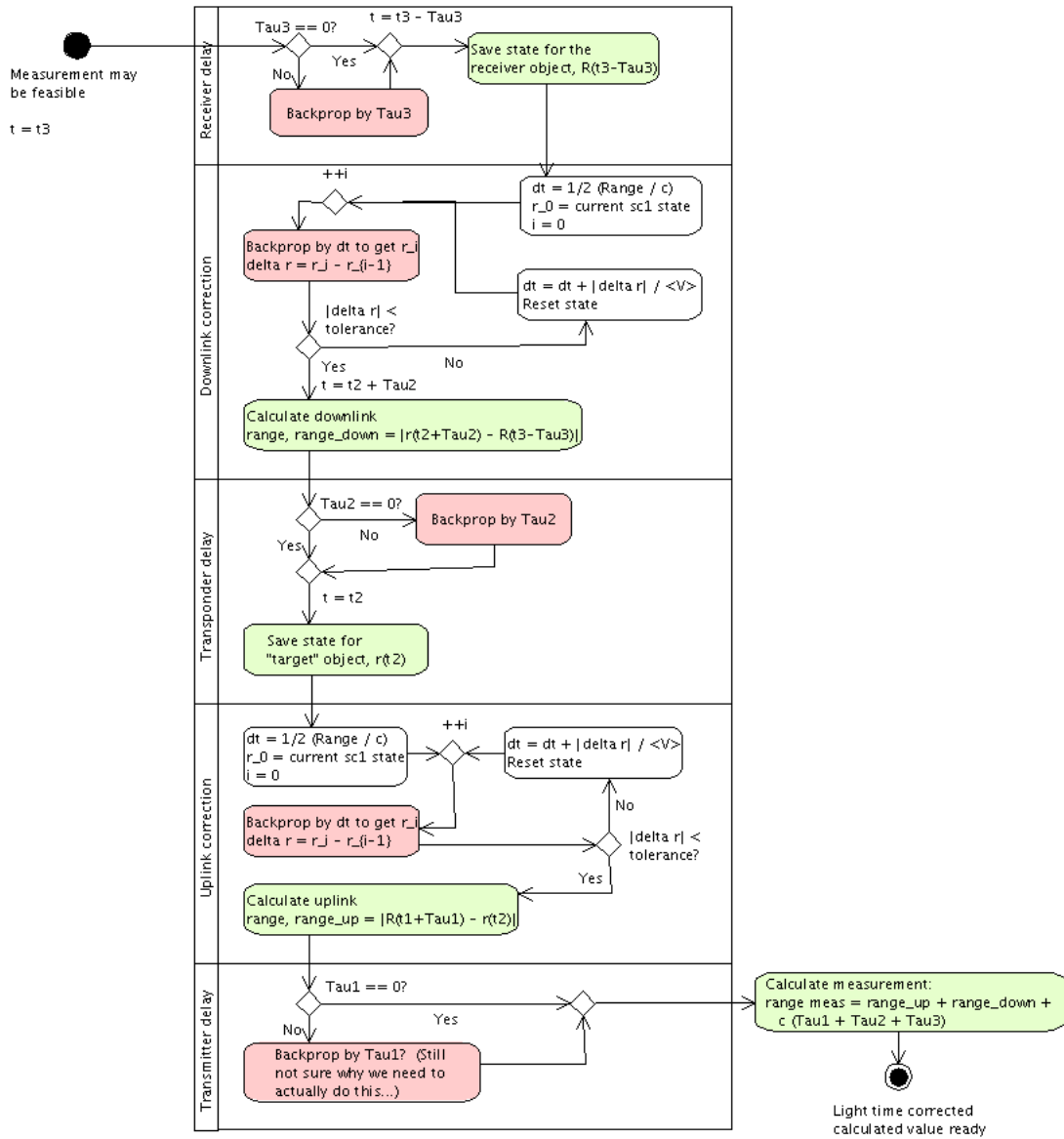

Figure 6.1: Steps in Light Time Correction: Two Way Range

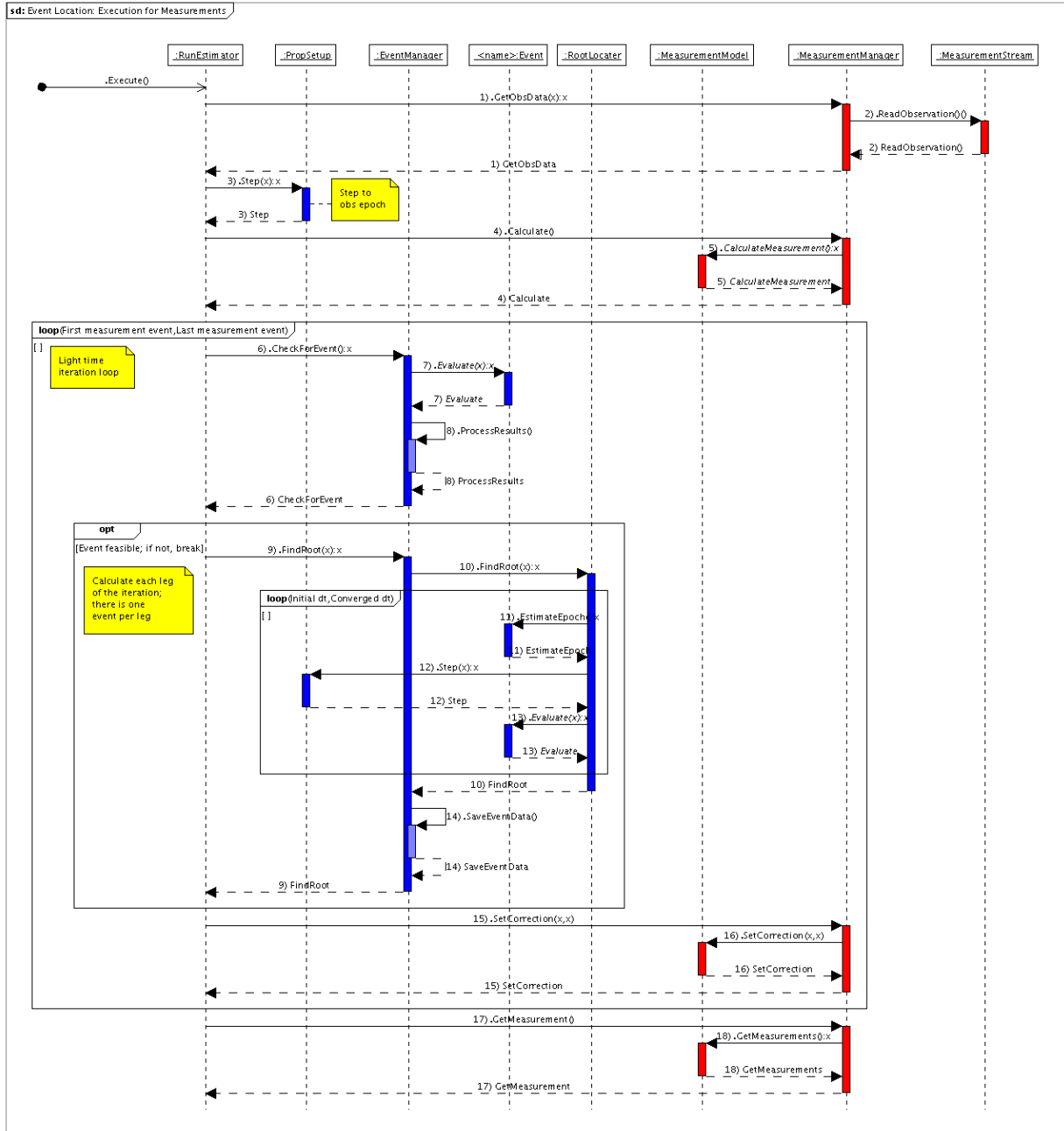

Figure 6.2: Event Location for Measurements

Draft for Release 2011a Beta

Part III

Estimation Examples

Draft for Release 2011a Beta

Bibliography

- [ArchSpec] GMAT Development Team, “GMAT Architectural Specification”, 2009.
- [Conway] Darrel J. Conway, “The GMAT Design Philosophy”, Internal Communications between Thinking Systems and Goddard, May 9, 2004.
- [Eckel] Bruce Eckel, “Thinking in C++”, Prentice-Hall, New Jersey, 2000.
- [MathSpec] Steven P. Hughes, “General Mission Analysis Tool (GMAT) Mathematical Specifications.”
- [NRecipes] William H. Press, Saul A. Teukolsky, William T. Vetterling, and Brian P. Flannery, **Numerical Recipes in C**, 2nd Edition, Cambridge University Press, 1992.
- [Vallado] D. Vallado, **Fundamentals of Astrodynamics and Applications**, 2nd Ed., Microcosm Press, 2001.